

onset[®]

Energy & Environmental Monitoring

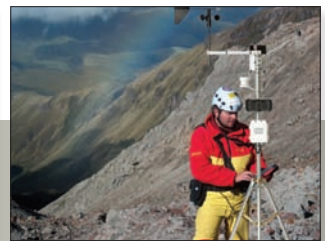
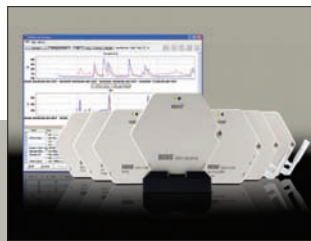

2010 Product Catalog

Sales & Support:
Intermountain Environmental, Inc.
(800)948-6236 or (435)755-0774
<http://www.inmtn.com>

HOB0[®] Data Loggers

onsetcomp.com

Product	Measurements	Page
Data Loggers/Indoor Environments		
HOBO U10	temperature, relative humidity	4-5
HOBO U12 Loggers	temperature, relative humidity, light intensity, AC current/voltage, 4-20mA, 0-2.5 VDC, carbon dioxide, gauge pressure, differential air pressure, water flow, air velocity, air flow, DC transducer	6-7
HOBO U14 LCD Loggers	temperature, relative humidity	8-10
HOBO U12 Stainless Logger	temperature	11
HOBO Thermocouple Loggers	wide range of temperature measurements (-200° to 1250° C) Type J, K, S, & T Thermocouples	12-13
HOBO Time-of-Use Loggers	state, light on/off, motor on/off	14-15
HOBO Measurement & Verification System	kW, AC Current	16-17
Wireless Sensor Networks		
HOBO ZW Series	temperature, relative humidity, kW, kWh AC current/voltage, 4-20mA, 0-2.5 VDC, carbon dioxide, gauge pressure, differential air pressure, water flow, air velocity, air flow, DC transducer	18-21
Data Loggers/Weatherproof		
HOBO Pro v2 Loggers	temperature, relative humidity	22-23
HOBO Rain Gauge	rainfall, temperature	24-25
HOBO Pendant Event	rainfall, temperature, event	26
HOBO U12 Outdoor Industrial	temperature, relative humidity, light intensity, AC current/voltage, 4-20mA, 0-2.5 VDC, carbon dioxide, gauge pressure, differential air pressure, water flow, air velocity, air flow, DC transducer	27
HOBOnode Wireless Sensors	temperature, soil moisture	28-31
Wireless/Weatherproof		
HOBOnode Wireless Sensors	temperature, soil moisture	28-31
Data Loggers/Waterproof		
HOBO Pendant Loggers	temperature, light intensity, tilt, acceleration	32-33
HOBO Water Temp Pro v2 Logger	temperature	34
TidbiT v2 Temp Logger	temperature	35
HOBO Water Level Loggers	temperature, water level	36-39
HOBO Conductivity Logger	temperature, conductivity	40-41
Data Logging Systems		
Data Logging Systems Comparison Chart		42
HOBO Micro Station	wind speed, wind direction, rainfall, soil moisture, solar radiation, PAR, barometric pressure, leaf wetness, 4-20mA input, voltage input, pulse input	43
HOBO U30 Remote Monitoring Systems	temperature, temp/rh, kW, kWh, gauge pressure differential air pressure, CO2, AC amps, DC amps, DC voltage, 4-20mA, VOC, water flow, air velocity, air flow, voltage, DC transducer, windspeed/direction, rainfall, soil moisture, leaf wetness, PAR, solar radiation, pulse input, barometric pressure	44-47
HOBO Energy Logger	temperature, relative humidity, light intensity, AC current/voltage, 4-20mA, 0-2.5 VDC, carbon dioxide, gauge pressure, differential air pressure, water flow, air velocity, air flow, DC transducer	48-49
Data Logging System – Accessories		50-51
Software		
HOBOWare		52-53
Alarm & Readout Tool		54
HOBOLink		55
Sensors		
Sensor Compatibility Guide		56-57
Sensors	temperature, temp/rh, kW, kWh, gauge pressure differential air pressure, CO2, AC voltage, AC amps, DC amps, DC voltage, 4-20mA, VOC, water flow, air velocity, air flow, DC transducer, windspeed/direction, rainfall, soil moisture, leaf wetness, PAR, solar radiation, pulse input, barometric pressure	58-69
Communications		
Data Shuttles/Base Stations		70-71
Services/Parts/Accessories		72-73
The Onset Advantage		74-75



HOBO U10 temperature data loggers are an economical choice for indoor temperature monitoring. Their small size and large memory capacity make these ideal multi-purpose loggers for a wide range of environmental monitoring projects.

Key Advantages:

- Small size for mounting anywhere
- Low cost lets you monitor many locations economically
- Internal sensors for easy deployment

Memory: 52,000 measurements
 Sample rate: 1 second to 18 hours, user-selectable
 Battery life: 1 year (typical)—user-replaceable 

Temperature

Measurement range: -20° to 70°C (-4° to 158°F)
 Accuracy: ± 0.54°C from 0° to 50°C (0.97°F from 32° to 122°F)
 Resolution (10-bit): 0.1°@ 25°C (0.2°@ 77°F)
 Response time: 10 minutes (to 90% in airflow of 1 m/s)



NIST-traceable temperature accuracy certificate available. (See page 72)

Relative Humidity (RH)

Measurement range: 25% to 95% RH
 Accuracy: ±3.5% RH from 25% to 95% over range of 5° to 55°C (41° to 131°F)
 Resolution (10-bit): 0.07% RH
 Response time: 6 minutes (to 90% in airflow of 1 m/s)

**Sales & Service: Intermountain Environmental, Inc.
 (800) 948-6236 or www.inmtn.com**

HOBO U10 Model Comparison

		Temperature	Temp/RH
		 U10-001	 U10-003
		\$65	\$81
Number of Channels		1	2
Internal Sensors	Temperature	yes	yes
	Relative Humidity	--	yes
Size	cm	6.0 x 4.7 x 1.9	6.0 x 4.7 x 1.9
	inches	2.4 x 1.9 x 0.8	2.4 x 1.9 x 0.8
Weight	grams	28	28
	ounces	0.9	0.9

Complete system requires logger and software.

Ordering Information

Data Loggers

HOBO U10 Temp	U10-001	\$65
HOBO U10 Temp/RH	U10-003	\$81

Software

HOBOWare Pro Software (Windows®/Mac®)	BHW-PRO-CD	\$99
HOBOWare Lite Software (Windows/Mac)	BHW-LITE-CD	\$45
Real-time Alarm Software Plug-in*	BHW-T-ALRM	\$55
<i>HOBOWare includes USB interface cable</i>		

Optional Communications

HOBO U-Shuttle*	U-DT-1	\$260
USB to Ethernet Server	SERVER-US-4	\$145

*Requires HOBOWare Pro software, see page 52 for details.

Prices subject to change

HOBOWare Software is available for download via the web. Visit onsetcomp.com for details.



HOBO U12 data loggers provide high-accuracy monitoring of temperature and humidity. The U12 loggers provide 12-bit resolution measurements for detecting greater variability in recorded data, direct USB connectivity for convenient, high-speed data offload, and a 43K measurement capacity. They also feature rugged enclosures for enhanced product durability.

Key Advantages:

- Large memory for long-term deployments or fast sampling
- Five models to choose from, with flexible measurement options
- Programmable as well as push-button start

Memory: 43,000 measurements
 Sample rate: 1 second to 18 hours, user-selectable
 Battery life: 1 year (typical)—user-replaceable 

Temperature

Measurement range: -20° to 70°C (-4° to 158°F)
 Accuracy: ± 0.35°C from 0° to 50°C (0.63°F from 32° to 122°F)
 Resolution (12-bit): 0.03° @ 25°C (0.05° @ 77°F)
 Response time: 6 minutes (to 90% in airflow of 1 m/s)

NIST-traceable temperature accuracy certificate available. (See page 72)

Relative Humidity (RH)

Measurement range: 5% to 95% RH
 Accuracy: ±2.5% typical, 3.5% maximum, from 10 to 90% RH
 Resolution (12-bit): 0.03% RH
 Response time: 1 minute (to 90% in airflow of 1 m/s)

Light Intensity







Designed for general purpose indoor measurement of relative light levels
 Range: 1 to 3000 footcandles (lumens/ft²) typical
 0-32,300 lumens/m² [0-3,000 footcandles (lumens/ft²)]

External Input

External sensors for temperature, AC current, AC voltage, CO₂, 4-20 mA, 0-2.5 VDC
(see sensors page 57)

Input range: 0 to 2.5 VDC
 Accuracy: ±2 mV, ±2.5% of absolute reading
 Resolution (12-bit): 0.6 mV
 Output power: 2.5 VDC at 2 mA, active only during measurements

HOBO U12 Model Comparison

		Temperature	4 External	Temp/RH	Temp/RH/Light/Ext	Temp/RH/2 Ext
						
		U12-001	U12-006	U12-011	U12-012	U12-013
		\$85	\$108	\$115	\$133	\$133
Number of Channels		1	4	2	4	4
Internal Sensors	Temperature	yes	--	yes	yes	yes
	Relative Humidity	--	--	yes	yes	yes
	Light Intensity	--	--	--	yes	--
External Sensors		--	yes	--	yes	yes
Size	cm	5.8 x 7.4 x 2.2	5.8 x 7.4 x 2.2	5.8 x 7.4 x 2.2	5.8 x 7.4 x 2.2	5.8 x 7.4 x 2.2
	inches	2.3 x 2.9 x 0.9	2.3 x 2.9 x 0.9	2.3 x 2.9 x 0.9	2.3 x 2.9 x 0.9	2.3 x 2.9 x 0.9
Weight	grams	46	46	46	46	46
	ounces	1.6	1.6	1.6	1.6	1.6

Complete system requires logger and software.

Ordering Information

Data Loggers

HOBO U12 Temp	U12-001	\$85
HOBO U12 4 Ext Channels	U12-006	\$108
HOBO U12 Temp/RH	U12-011	\$115
HOBO U12 Temp/RH/Light/Ext Channel	U12-012	\$133
HOBO U12 Temp/RH/2 Ext Channels	U12-013	\$133

kW**

3 Phase, 450V, 100 AMP	T-VER-8044-100	\$815
------------------------	----------------	-------

Gauge Pressure**†

100 psig	T-ASH-G2-100	\$190
200 psig	T-ASH-G2-200	\$190
500 psig	T-ASH-G2-500	\$190

Differential Air Pressure Transducer**†

.01-10.0 WC	T-VER-PXU-L	\$220
.01-10.0 WC	T-VER-PXU-X	\$195

Humidity**†

Duct-Mount RH/Temp	T-VAI-HMD-40Y	\$299
--------------------	---------------	-------

DC Current**†

0-200 Amp	T-VER-H970-200	\$205
-200 to 200 Amp	T-VER-971BP-200	\$299

Air Velocity Sensor**†

0.15-10 m/s	T-DCI-F900-L-P	\$319
0.15-5 m/s	T-DCI-F900-L-O	\$319
0.15-10 m/s	T-DCI-F900-S-P	\$235
0.15-5 m/s	T-DCI-F900-S-O	\$235

Compressed Air Flow Meter**

1-80 SCFM	T-CDI-5200-10S	\$495
3-350 SCFM	T-CDI-5400-20S	\$629

Volatile Organic Compound (VOC)**†

0-10, 0-100, 0-1000 ppm	T-ION-TVOC	\$2995
-------------------------	------------	--------

Temperature Sensors

Air/Water/Soil Probe 0.3m (1ft)	TMC1-HD	\$32
Air/Water/Soil Probe 1.8m (6ft)	TMC6-HD	\$35
Air/Water/Soil Probe 6.1m (20ft)	TMC20-HD	\$40
Air/Water/Soil Probe 15.2m (50ft)	TMC50-HD	\$45
Stainless Steel Temp Probe 1.8m (6ft)	TMC6-HC	\$79
Pipe Temp 1.8m (6ft)	TMC6-HE	\$35

Split-core AC Current Sensors

0-20 Amps AC	CTV-A	\$90
0-50 Amps AC	CTV-B	\$90
0-100 Amps AC	CTV-C	\$90
0-200 Amps AC	CTV-D	\$115
0-600 Amps AC	CTV-E	\$115

CO₂**

Telaire CO ₂ /Temp Monitor	TEL-7001	\$465
---------------------------------------	----------	-------

AC Voltage Transmitters**

0 - 150 Volts AC	T-CON-ACT-150	\$139
0 - 300 Volts AC	T-CON-ACT-300	\$139

DC Voltage

0 - 2.5 Volts DC	CABLE-2.5-STEREO	\$9
0 - 5 Volts DC	CABLE-ADAP5	\$12
0 - 10 Volts DC	CABLE-ADAP10	\$12

Milliamps

4 - 20mA	CABLE-4-20MA	\$25
----------	--------------	------

Software

HOBOware Pro Software (Windows®/Mac®)	BHW-PRO-CD	\$99
HOBOware Lite Software (Windows®/Mac®)	BHW-LITE-CD	\$45
Real-Time Alarm Software Plug-in*	BHW-T-ALRM	\$55

Optional Communications

HOBO U-Shuttle*	U-DT-1	\$260
USB to Ethernet Server	SERVER-US-4	\$145

* Requires HOBOware Pro software, see page 52 for details.

HOBOware includes USB interface cable.

** Requires input cables. See page 57 for compatibility.

† Requires sensor power adapter (AC-SENS-1) See page 57 for compatibility.

Prices subject to change

HOBOware Software is available for download via the web. Visit onsetcomp.com for details.



HOB0 U14 LCD data loggers display and record temperature and humidity conditions. They are well-suited for use in manufacturing, processing, and storage environments where reliable monitoring and documentation of specific temp/RH conditions are critical.

Key Advantages:

- Real-time display of temperature and relative humidity
- Alarm display and output ensure timely notification of out-of-range conditions
- Two models to choose from—Internal Temp/RH or External Temp/RH sensors
- Optional protective case for outdoor environments
- Optional Remote Alarm and Autodialer
- Fast data downloading via USB

Memory: 43,000 measurements
 Sample rate: 1 second to 18 hours
 Battery life: 1-year (typical)—user-replaceable
 Operating range: -20° to 50°C (-4° to 122°F) 0 to 100% RH non-condensing



Weatherproof case (CASE-4x) required for outdoor use. HOB0 U14-001 is not suitable for outdoor use.

Internal Temperature Measurement

Temperature Measurement

Range: -20° to 50°C (-4° to 122°F)
 Accuracy: ±0.2°C from 0° to 50°C (±0.36°F from 32° to 122°F)
 Resolution (12 bit): 0.03°C @ 25°C (0.05° @ 77°F)
 Response time: 15 minutes (to 90% in airflow of 1 m/s)

Internal RH Measurement

Range: 0 - 100% RH, -20° to 50°C (-4° to 122°F)
 Accuracy: ±2.5% typical, 3.5% maximum, from 10 to 90% RH
 Resolution (12 bit): 0.03% RH @ 25°C (77°F)
 Response time: 2 minutes (to 90% in airflow of 1 m/s)



12-bit Temperature Probe

\$95 S-TMB-M002*
 \$105 S-TMB-M006*
 \$120 S-TMB-M017*

Temperature Measurement

Range: -40° to 100°C (-40° to 212°F) for sensor tip only
 Accuracy: ±0.2°C from 0° to 50°C (±0.36°F from 32° to 122°F)
 Resolution (12-bit): 0.03°C @ 25°C (0.05° @ 77°F)
 Response time: 2 minutes (to 90% in airflow of 1 m/s)



***Last two digits of product number indicate sensor cable length (in meters).**



**External Temperature/
RH Probe**

\$189 S-THB-M002*
\$195 S-THB-M008*

**Temperature
Measurement**

Range: -40° to 75°C (-40°F to 167°F)
Accuracy: ±0.2°C from 0° to 50°C (0.36°F from 32° to 122°F)
Resolution (12 bit): 0.03°C @ 25°C (0.05°F @ 77°F)
Response time: 5 minutes (to 90% in airflow of 1 m/s)

**RH
Measurement**

Range: 0 - 100% RH, -40° to 75°C (-40° to 167°F)
Accuracy: ±2.5% typical, 3.5% maximum, from 10 to 90% RH
Resolution (10 bit): 0.1% RH @ 25°C (77°F)
Response time: 10 minutes (to 90% in airflow of 1 m/s)
with protective cap



***Last two digits of product number indicate sensor cable length (in meters).**



Remote Alarm
\$95 ARA

Remote Alarm

- Adjustable audible alarm level (soft/loud)
- Self-test confirms proper indicator operation
- Two inputs provide alarm notification for separate zones
- 1 year battery life (typical)—user-replaceable
- Battery status indication



Auto Dialer
\$179 AVD-45

Auto Dialer

- Dials up to 4 different numbers
- Transmits either voice or numeric messages (for pagers)
- Automatically redials busy or unanswered numbers (up to 10 times for each number)
- AC powered (AC adapter included)
- Internal 9V alkaline battery provides 4 hours of stand-by power
- Works alone or in conjunction with remote alarm



**Protective Case
for LCD Logger**
\$79 CASE-4x
1.7 x 12.7 x 5.7 cm
(6.75 x 2.25 in)
315.2 g (11.2 oz)

Protective Case

- Tested to NEMA 4X (IP65) Standards
- External Temperature or Temperature/RH sensor and alarm relay cables feed through watertight grommets
- Easy data readout via removable watertight fitting with O-ring seal
- Hook and loop tape secures LCD logger inside case
- Materials: Polycarbonate body and cover—UV stabilized

Note: Protective Case is for use with the U14-002 HOB0 LCD Data Logger with external input from remote Temperature or Temperature/RH sensors. Check the HOB0 LCD Sensor specifications to assure that the unprotected external sensor is recommended for your operating environment.

NIST-traceable accuracy certification is available. (See page 72)

HOBO U14 Model Comparison



Internal Temp/RH



U14-001

External Temp or Temp/RH



U14-002

External Sensors sold separately. See pages 8 and 9.

		\$209	\$169
Internal Sensors	Temperature	yes	--
	Relative Humidity	yes	--
External Sensor	Temperature	--	yes
	Relative Humidity	--	yes
Size	cm	12.4 x 9.1 x 3.0	12.4 x 9.1 x 3.0
	inches	4.9 x 3.6 x 1.2	4.9 x 3.6 x 1.2
Weight	grams	170	170
	ounces	6	6

Ordering Information

Data Loggers

HOBO U14 Temp/RH (Internal Temp/RH)	U14-001	\$209
HOBO U14 Temp/RH (External Temp or Temp/RH)	U14-002	\$169

Software

HOBOWare Pro Software (Windows/Mac)	BHW-PRO-CD	\$99
HOBOWare Lite Software (Windows/Mac)	BHW-LITE-CD	\$45
Real Time Alarm Software Plug-in*	BHW-T-ALRM	\$55

Sensors

Stainless Steel Temperature Probe	S-TMB-M002	\$95
	S-TMB-M006	\$105
	S-TMB-M017	\$120
External Temperature/RH Probe	S-THB-M002	\$189
	S-THB-M008	\$195

Communications and Accessories

Two-Zone Remote Alarm	ARA	\$95
Protective Case for LCD Logger	CASE-4x	\$79
Auto Dialer	AVD-45	\$179
HOBO U-Shuttle*	U-DT-1	\$260

*Requires HOBOWare Pro software, see page 52 for details.

Prices subject to change

HOBOWare Software is available for download via the web. Visit onsetcomp.com for details.

HOBO U12 Stainless temperature data loggers are ideal for food, pharmaceutical, autoclave, and other applications where high-accuracy temperature data is critical. They can withstand process conditions from pasteurization to flash freezing and washdown.

Key Advantages:

- High-accuracy, extended temperature range
- Suitable for high pressure applications to 2200psi
- Fast readout via direct USB interface

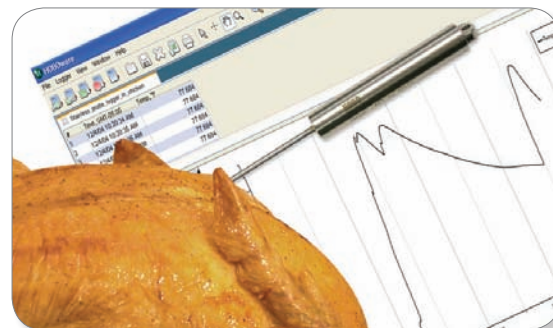

Memory: 43,000 measurements
 Sample rate: 1 second to 18 hours, user-selectable
 Battery life: 3-years (typical)—factory-replaceable 

Temperature Measurement

range: -40° to 125°C (-40° to 257°F)
 Accuracy: ± 0.25°C from 0° to 50°C (0.45°F from 32° to 122°F)
 Resolution 12 bit: 0.02°@ 25°C (0.04°@ 77°F)
 Response time:
 U12-015: 10 minutes (to 90% in airflow of 1 m/s)
 U12-015: 3.5 minutes (to 90% in water)

U12-015-02: 2.25 minutes (to 90% in airflow of 1m/s)
 U12-015-02: 20 seconds (to 90% in water)

NIST-traceable temperature accuracy certification available. (See page 72).



HOBO U12 Stainless Temperature Logger

\$259 U12-015
 101.6 x 17.5 mm diameter
 (4.0 x 0.69 in diameter)



HOBO U12 Stainless Temperature Logger 5 inch Probe

\$355 U12-015-02
 12.4 x 0.4 cm diameter
 (4.9 x 0.16 in diameter)

Complete system requires logger and software.

Ordering Information

Data Loggers

HOBO U12 Stainless Temperature Logger	U12-015	\$259
HOBO U12 Stainless Temperature Logger 5" Probe	U12-015-02	\$355

Software

HOBOware Pro Software (Windows/Mac)	BHW-PRO-CD	\$99
HOBOware Lite Software (Windows/Mac)	BHW-LITE-CD	\$45
<i>HOBOware includes USB interface cable</i>		

Optional Communications

HOBO U-Shuttle*	U-DT-1	\$260
-----------------	--------	-------

**Requires HOBOware Pro software, see page 52 for details.*

Prices subject to change

HOBOware Software is available for download via the web. Visit onsetcomp.com for details.



Thermocouple Logger
HOBO U12 J, K, S, T
\$129 U12-014
 5.8 x 7.4 x 2.2 cm
 (2.3 x 2.9 x 0.85 in)
 46 g (1.6 oz)

The HOBO U12 J, K, S, T Thermocouple data logger provides exceptional measurement flexibility by accepting J, K, S, or T thermocouple probes.

Key Advantages:

- High-accuracy J, K, S, T thermocouple recordings
- Automatic cold-junction compensation
- Accepts industry-standard subminiature thermocouple connectors

Memory: 43,000 measurements
 Sample rate: 1 second to 18 hours (user-selectable)
 Battery life: 1-year (typical)—user-replaceable

Temperature	Temperature Ranges	Accuracy	Resolution (12-bit)
with J Thermocouple	0° to 750°C (32° to 1382°F)	± 2.5°C or 0.5% of reading, whichever is greater	0.21° @ 375°C (0.38° @ 707°F)
with K Thermocouple	0° to 1250°C (32° to 2282°F)	± 4.0°C or 0.5% of reading, whichever is greater	0.32° @ 625°C (0.58° @ 1157°F)
with S Thermocouple	-50° to 1760°C (-58° to 3200°F)	± 6.0°C or 0.5% of reading, whichever is greater	0.44° @ 855°C (0.79° @ 1571°F)
with T Thermocouple	-200° to 100°C (-328° to 212°F)	±1.5°C (±2.7°F)	0.10° @ -50°C (0.18° @ -58°F)

Data Loggers/ Indoor Environments



Beaded Thermocouple Probes on Spool Caddies
\$19 TC6-J, TC6-K, TC6-T
 1.8 m (6 ft)

Probe and Wires

Exposed-junction thermocouple probes include 6 ft of insulated 30-AWG wire wound on an integrated spool caddy/ subminiature connector

100' coils of insulated 24-AWG thermocouple wire



Thermocouple Wire
\$59 TCW100-J, TCW100-K, and TCW100-T
 30.5 cm (100 ft.)

Temperature	Temperature Ranges	Accuracy
Type J TEFLON insulation:	0° to 250°C (32° to 482°F)	±2.2°C (±4°F)
Type K glass braid insulation:	0° to 285°C (32° to 545°F)	±2.2°C (±4°F)
	285° to 482°C (545° to 900°F)	±0.75%
Type T TEFLON insulation:	-200° to -65°C (-330° to -85°F)	±1.5%
	-65° to 130°C (85° to 270°F)	±1.0°C (±1.8°F)
	130 to 180°C (270° to 356°F)	±0.75%



**High-temperature
Stainless Steel Probe**
— Type K
\$39 TCP6-K12
30.5 cm (12 in)

Temperature Ranges	Accuracy
0° to 293°C (32° to 559°F)	±2.2°C (±4°F)
293° to 900°C (559° to 1650°F)	±0.75%**

** **Percentage is of degrees above or below 0°C (32°F)**

- 12 in 304 stainless-steel probe; 3/16in diameter with isolated thermocouple
- 1 in Handle with spring-type strain relief
- 6 ft 19-AWG cable

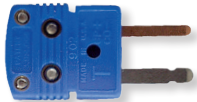

**Subminiature
Thermocouple Connectors**
\$9 SMC-J, SMC-K, SMC-T

- Accept stranded or solid wire up to 20 AWG Internal silicone grommet for strain relief
- Captive cover screws
- Write-on window
- Type J, K, and T versions available

Complete system requires logger, temperature probe(s), and software.

Ordering Information

Thermocouple Logger

HOBO U12 J, K, S, T

\$129

Thermocouple Probes and Wires

1.8 m (6 ft) Beaded Thermocouple with connector—J Type	TC6-J	\$19
1.8 m (6 ft) Beaded Thermocouple with connector—K Type	TC6-K	\$19
1.8 m (6 ft) Beaded Thermocouple with connector—T Type	TC6-T	\$19
30.5 cm (12 in) Stainless-Steel Probe Thermocouple—K Type	TCP6-K12	\$39
30.5 m (100 ft) of 24-AWG Thermocouple wire—J Type	TCW100-J	\$59
30.5 m (100 ft) of 24-AWG Thermocouple wire—K Type	TCW100-K	\$59
30.5 m (100 ft) of 24-AWG Thermocouple wire—T Type	TCW100-T	\$59

Thermocouple Connectors

Subminiature Type J	SMC-J	\$9
Type K	SMC-K	\$9
Type T	SMC-T	\$9

Software

HOBOware Pro Software (Windows/Mac)	BHW-PRO-CD	\$99
HOBOware Lite Software (Windows/Mac)	BHW-LITE-CD	\$45

HOBOware includes USB interface cable

Optional Communications

HOBO U-Shuttle*	U-DT-1	\$260
USB to Ethernet Server	SERVER-US-4	\$145

*Requires HOBOware Pro software, see page 52 for details.

Prices subject to change

HOBOware Software is available for download via the web. Visit onsetcomp.com for details.



HOBO Time-of-Use Loggers come in a choice of four models that record state changes, light on/off, motor run-times, and/or events.

Key Advantages:

- Compact size for easy deployment
- Internal light, motor field, or magnetic reed switch sensors
- State and event channels with external inputs provides extra reliability

Memory: 26,000 to 43,000 measurements
(based on state-change interval)

Battery: 1-year (typical) – user-replaceable 

State Logger

Options for monitoring:

- Internal magnetic reed switch and external magnet
- External input cable for monitoring DC voltages up to 15V contact closure, open collector output, or presence of positive DC
- Can be used with the CSV-A8 Current Switch for motor on/off

Spacing between magnet and logger:
Contact closure resistance:

Open ≥ 0.75 in, Closed ≤ 0.25 in
Open > 300 k ohms, Closed < 15 k ohm

Light On/Off Logger

Internal light sensor monitors on/off of fluorescent or incandescent lamps. The light sensitivity is peaked in the forward range and can be utilized to minimize the effect of other light sources when trying to determine the on/off state of a particular light source.

Light intensity threshold:

10 to 100 lumens/m² [0.93 to 9.3 footcandles (lumens/ft²) (fluorescent light)], adjustable. For incandescent lamps the threshold is about ten times greater than above.

Motor On/Off Logger

Internal sensor monitors the AC field generated by motors, transformers, or a single wire carrying a large AC current. The logger can be conveniently mounted directly on a motor housing without requiring access to the motor internals.

Note that this logger must be mounted very close to the field source as magnetic intensities fall off rapidly with increasing distance from their source.

AC magnetic field threshold:

750 m Gauss @ 60 Hz (depending on distance and orientation)

3-State Logger/1-Event

Simultaneously monitors and logs state changes in up to three locations, as well as one time/date-stamped event. Can be used with CSV-A8 Current Switch.

State channels (3)

External contact input: Passive relay switch or contact closure
Minimum duration: 1 second (open or closed)

Event channel (1)

External contact input: Passive relay switch or contact closure
Event resolution: 1 second
Minimum pulse length: 2.5 milliseconds
Maximum total cable: 32 m (105 ft) (if using state and event channels)
64 m (210 ft) (if using state channels only)

Contact closure resistance: Open > 300 k ohms
Closed < 10 k ohms



AC Current Switch

- Can be used with any state channel on U9-001 or U11-001 loggers
- Installs around a current-carrying wire to provide a relay signal indicating equipment on/off
- Adjustable threshold provides maximum application flexibility
- UL listed



AC Current Switch

\$89 CSV-A8

5.9 x 5.1 x 2.3 cm
(2.32 x 2.0 x 0.92 in)

Amperage range: .05 to 175 Amps continuous
 Sensor supply voltage: Induced from monitored conductor, with no external power required
 Isolation: 600 VAC rms (max voltage when monitoring an uninsulated conductor)
 Status output ratings: N.O. 1.0A @ 30 VAC/DC max, not polarity-sensitive

HOBO Time-of-Use Logger Comparison

		State	Light On/Off	Motor On/Off	3 State/1 Event
		U9-001	U9-002	U9-004	U11-001
		\$85	\$79	\$85	\$125
Number of Channels		1	1	1	4
Internal Sensors	State Open/Closed	yes	--	--	3 State /1 Event
	Light On/Off	--	yes	--	--
	Motor On/off	--	--	yes	--
External Sensor	Motor On/Off	yes	--	--	yes
Size	cm	6.0 x 4.7 x 1.9	6.0 x 4.7 x 1.9	6.0 x 4.7 x 1.9	5.8 x 7.4 x 2.2
	inches	2.4 x 1.9 x 0.8	2.4 x 1.9 x 0.8	2.4 x 1.9 x 0.8	2.3 x 2.9 x 0.9
Weight	grams	25	25	29	50
	ounces	0.8	0.8	1	1.8

Complete system requires logger and software.

Ordering Information

Data Loggers

HOBO U9 State	U9-001	\$85
HOBO U9 Light On/Off	U9-002	\$79
HOBO U9 Motor On/Off	U9-004	\$85
HOBO U11 3 State/1 Event	U11-001	\$125

Software

HOBOWare Pro Software (Windows/Mac)	BHW-PRO-CD	\$99
HOBOWare Lite Software (Windows/Mac)	BHW-LITE-CD	\$45

HOBOWare includes USB interface cable

Sensors

AC Current Switch	CSV-A8	\$89
-------------------	--------	------

Optional Communications

HOBO U-Shuttle*	U-DT-1	\$260
USB to Ethernet Server	SERVER-US-4	\$145

*Requires HOBOWare Pro software, see page 52 for details.

Prices subject to change

HOBOWare Software is available for download via the web. Visit onsetcomp.com for details.



HOBO Measurement & Verification System

\$899 Single-phase KIT-MV-1P

\$999 Three-phase KIT-MV-3P

The HOBO Measurement & Verification System is a portable, self-contained energy logging system used for measuring, analyzing, and documenting building energy performance.

The system contains a 4-channel logger, kWh transducer for 120 and 240 VAC, 50 and 200 Amp current transducer, voltage input leads, HOBOWare Pro software, and accessories for single or three-phase circuit energy monitoring applications, all housed in a rugged carrying case.

Key Advantages:

- Single-phase 120-240 VAC and three-phase 120-240VAC models available
- Pre-wired sensors for quick and easy setup
- Weather proof enclosure for monitoring in harsh environments
- Measures kW and kWh

Data Loggers/ Indoor Environments

HOBO Measurement & Verification System Includes

Model	KIT-MV-1P	KIT-MV-3P
Price	\$899	\$999
# of Electrical Service Types system can monitor	3	5
HOBO 4 channel Microstation data logger	1	1
Electric switch pulse input adapter	1	1
0 - 50 AMP split-core AC Current Transformer	1	3
0 - 200 AMP split-core AC Current Transducer	1	3
kWh Transducer (120 or 240 VAC)	1	1
Voltage input lead set	1	1
HOBOWare Pro Software (Windows/Mac)	1	1
USB-serial adapter	1	1
Quick start guide	1	1
Carrying Case	Included	Included



Temperature/RH
\$189-\$195 S-THB-M00x
 cable lengths available
 2 m, 8 m (6.5 ft, 26 ft)

Ranges: -40° to 75°C (-40° to 167°F); 0 to 100% RH from -40° to 75°C (-40° to 167°F)
 Accuracy: ± 0.2° @ 25°C (±0.36° @ 77°F); ± 2.5% typical, 3.5% maximum, from 10 - 90% RH
 Resolution: 0.02° @ 25°C (0.04° @ 77°F); 0.1% RH @ 25°C (77°F)
 Response time: Temp: 5 minutes, RH: 5 minutes (to 90% in airflow of 1 m/s)
 Data channels: 2

Solar radiation shield (RS3) recommended for accurate temperature measurements in sunlight.



12-bit Temperature
\$95-\$120 S-TMB-M0xx
 2 m, 6 m, 17 m
 cable lengths available:
 (6.5 ft, 20 ft, 56 ft)

Range: -40° to 100°C (-40° to 212°F) for sensor tip only
 Accuracy: ± 0.2° from 0° to 50°C (±0.36° from 32° to 122°F)
 Resolution: 0.03° from 0° to 50°C (0.054° from 32° to 122°F)
 Environment: Sensor tip and cable rated for 1-year immersion in fresh water ≤ 50°C (122°F)
 Response time: < 2 minutes (to 90% in airflow of 1 m/s)

Solar radiation shield (RS3) recommended for accurate temperature measurements in sunlight.

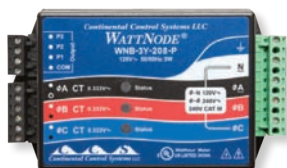

kWh Transducer
\$269 T-WNB-3D-480

Works with CTs (T-MAG-SCT-XXX) to provide True RMS kilowatt hours of energy used, even for loads with non-sinusoidal waveforms.
 Ranges: 480 VAC ±15% Delta and Wye systems
 Accuracy: ±0.45% of reading ±0.05% FS through 25th harmonic



AC Current
\$55-\$65 T-MAG-SCT-XXX

Ranges: 0-5, 0-20, 0-50, 0-100, 0-200, 0-600 Amps
 Accuracy: ±1% (from 10% to 130% of rated voltage)



Contact Closure Pulse Input Adapter
\$70-\$75 S-UCC-M00x
 cable lengths available:
 1 M, 6 M (3.3 ft, 21 ft)

This smart sensor is compatible with electronic switch closures, such as FET or open-collector outputs or CMOS-level logic signals with a maximum input frequency of 120 Hz (120 pulses per second).

Range: 120 Hz (120 pulses per second)
 Resolution: 1 pulse
 Data channels: 1



For more sensor options, see page 57

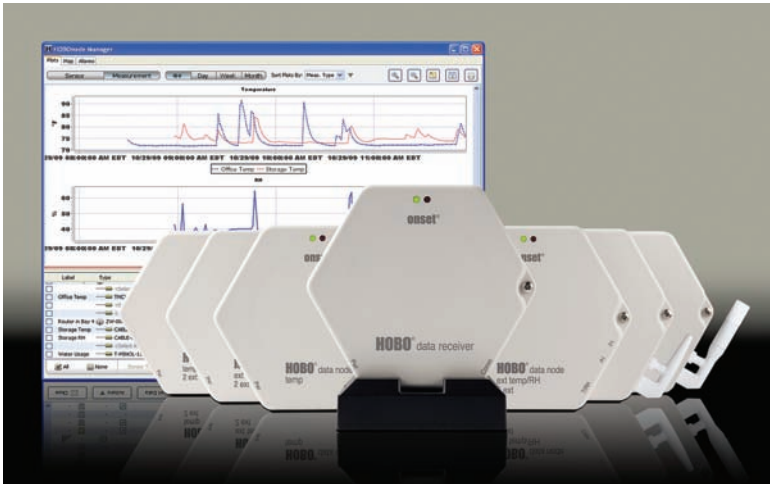

HOBO ZW Series is a family of wireless data nodes that provide centralized monitoring of energy and environmental conditions in buildings.

Best suited for on-site facility monitoring applications where web-based data access is not required, HOBO data nodes transmit high-accuracy, real-time data from dozens of points to a central PC. This eliminates the need of having to manually retrieve and offload individual data loggers, saving you time and money.

Measurements:

Temperature	Compressed airflow
Relative humidity	DC current
AC voltage	Differential pressure
AC current	Water usage
Kilowatts	4-20 mA
Kilowatt hours	0-10 vdc
Gauge pressure	Pulse
CO ₂	

Key Advantages:

- Provides centralized building performance data collection
- Transmission of real-time data within a self-healing mesh network eliminates line-of-sight issues
- Automatically routes data back to receiver
- Onboard buffer memory helps prevent data loss
- Alarm notification via email or text messages
- Powerful software for organizing and viewing data
- Map deployed data nodes
- Label and group data nodes for easy identification

Centralized Data Collection

HOBO data nodes, routers, and receivers all work together as a system to provide reliable, accurate real-time information on how a building is performing. Whether you are a warehouse manager looking to keep a close eye on temperature and humidity conditions, a facility manager looking at indoor air quality, or a building energy manager tracking energy use, HOBO data nodes provide reliable data collection without the hassles of manually offloading data.

Self-Healing Technology

HOBO data nodes leverage MESH networking technology, which ensures that data is automatically re-routed back to the receiver without any manual intervention.

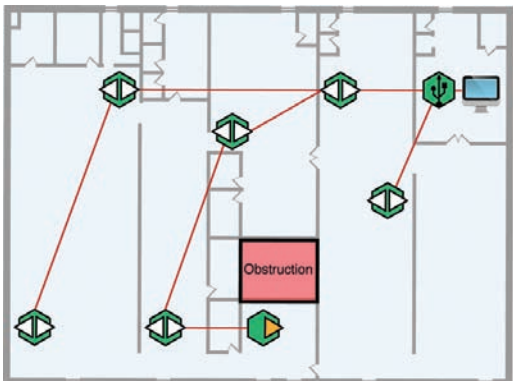

Scenario 1. Typical data flow back to the receiver

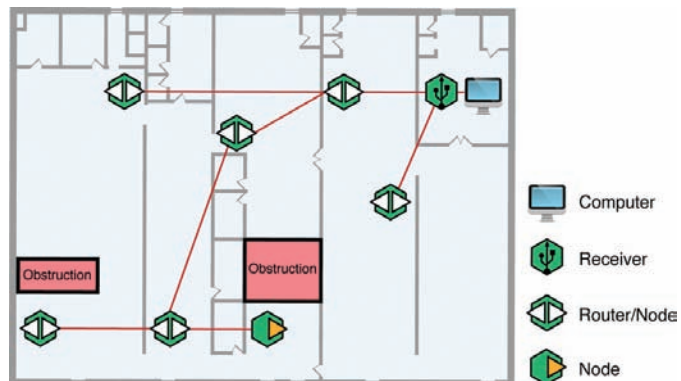

Scenario 2. Self healing network automatically compensates for new obstruction



HOBOWare Pro 3.0 is included with the ZW Receiver

Advanced Software Capabilities

HOBOnode™ Manager software, a component of HOBOWare Pro graphing and analysis software, lets you view real-time energy and environmental data, set alarm notifications, and get an at-a-glance view of your network with the Network Map feature. HOBOnode Manager software also offers one-click export of your data to Microsoft Excel and other programs, and provides network signal strength indication.

Alarm Capabilities:

- HOBOnode Manager software will send a text message to your phone and email your computer when conditions exceed set thresholds.
- System alarms lets you know if a data node is not connected to your network.

Network Map Feature

In many monitoring applications, it's important to view a complete network of your HOBOWare Data Nodes. HOBOnode Manager's Network Map feature provides an at-a-glance view of your network so you can easily locate your HOBOWare Data Nodes within a building.

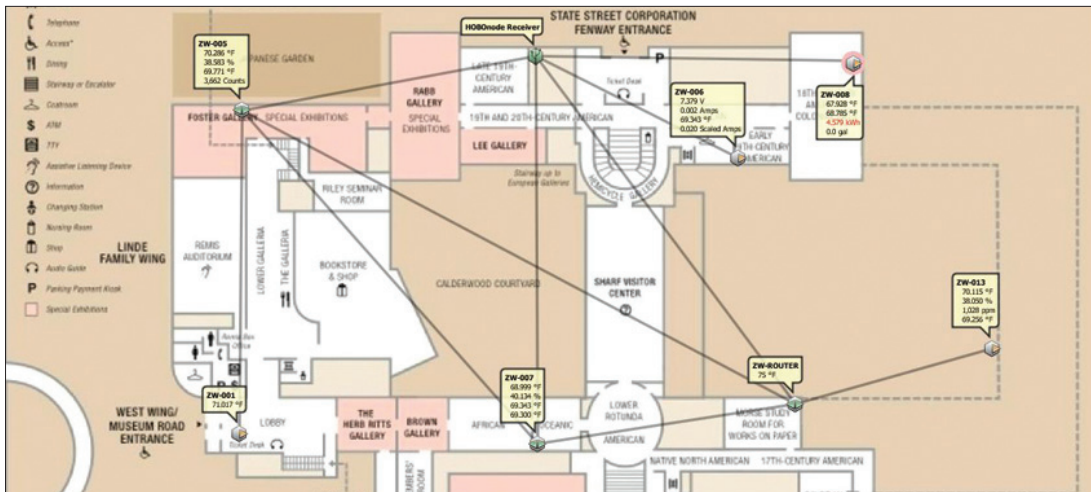

HOBOnode manager's Network Map feature provides at-a-glance view of a HOBOWare data node network.

Sales & Service: Intermountain Environmental, Inc.
 (800) 948-6236 or www.inmtn.com

Wireless/ Indoor Environments

Specifications

	ZW-RCVR (Receiver)	Available in June 2010 ZW-001	Available in June 2010 ZW-003	ZW-005**	ZW-006	ZW-007**	ZW-008	ZW-ROUTER (Router)
	\$199	\$159	\$239	\$289	\$209	\$289	\$209	\$149
Measurements	N/A	Temp	Temp, RH	External T/RH, 1 analog port, 1 pulse input port	4 external analog ports	External T/RH, 2 analog ports	2 analog ports, 2 pulse input ports	N/A
Probe Size				1cm (0.38 in) diameter probe on 1.8 m (6ft cable)		1cm (0.38 in) diameter probe on 1.8 m (6ft cable)		
Buffer memory	up to 95k measurements	5k measurements	4k measurements	3k measurements	3k measurements	3k measurements	3k measurements	N/A
Sample rate	N/A	1 min to 18 hrs	1 min to 18 hrs	1 min to 18 hrs	1 min to 18 hrs	1 min to 18 hrs	1 min to 18 hrs	N/A
Transmission rate	N/A	2 min and greater	2 min and greater	2 min and greater	2 min and greater	2 min and greater	2 min and greater	N/A
Power options	AC power adapter, USB, Battery	AC power adapter, Battery Backup	AC power adapter, Battery Backup	AC power adapter, Battery Backup	AC power adapter, Battery Backup	AC power adapter, Battery Backup	AC power adapter, Battery Backup	AC power adapter, Battery Backup
Measurement range	N/A	Temp: -40° to 70° C (-40° to 158° F)	Temp: -40° to 70° C (-40° to 158° F) RH: 5 to 95% RH	Temp: -40° to 70° C (-40° to 158° F) RH: 5 to 95% RH Analog channels: 0 to 2.5 Vdc; 0 to 5 Vdc (w/CABLE-ADAP5); 0 to 10 Vdc (w/ CABLE-ADAP10) 4-20 mA Pulse channel: 0 to 65,535 pulses per logging interval	Analog channels: 0 to 2.5 Vdc; 0 to 5 Vdc (w/CABLE-ADAP5); 0 to 10 Vdc (w/ CABLE-ADAP10)	Temp: -40° to 70° C (-40° to 158° F) RH: 5 to 95% RH Analog channels: 0 to 2.5 Vdc; 0 to 5 Vdc (w/ CABLE-ADAP5); 0 to 10 Vdc (w/ CABLE-ADAP10).	Analog channels: 0 to 2.5 Vdc; 0 to 5 Vdc (w/ CABLE-ADAP5); 0 to 10 Vdc (w/ CABLE-ADAP10). 4-20 mA Pulse channel: 0 to 65,535 pulses per logging interval	N/A
Accuracy	N/A	Temp: ± 0.2° C over 0° to 50° C (± 0.36° F over 32° C to 122° F)	Temp: ± 0.2° C over 0° to 50° C (± 0.36° F over 32° to 122° F) RH: ± 2.5% from 10 to 90% typical, max. ± 3.5%	Temp: ± 0.2° C over 0° to 50° C (± 0.36° F over 32° to 122° F) RH: ± 2.5% from 10 to 90% typical, max. ± 3.5% Analog: ± 1.544 mV plus 2% of reading (typical)	Analog: ± 1.544 mV plus 2% of reading (typical)	Temp: ± 0.2° C over 0° to 50° C (± 0.36° F over 32° to 122° F) RH: ± 2.5% from 10 to 90% typical, max. ± 3.5% Analog: ± 1.544 mV plus 2% of reading (typical)	Analog: ± 1.544 mV plus 2% of reading (typical)	N/A
Resolution	N/A	Temp: 0.02° C @ 25° C (0.04° F @ 77° F)	Temp: 0.02° C @ 25° C (0.04° F @ 77° F) RH: 0.03%	Temp: 0.02° C @ 25° C (0.04° F @ 77° F) RH: 0.03% Analog channel: 0.6 mV Pulse Channel: 1 pulse	Analog channel: 0.6mV	Temp: 0.02° C @ 25° C (0.04° F @ 77° F) RH: 0.03% Analog channel: 0.6 mV	Analog channel: 0.6mV Pulse Channel: 1 pulse	N/A
Response time	N/A	Temp: 5 min. in air moving 1 m/s (3.3 ft/sec)	Temp: 5 min. in air moving 1 m/s (3.3 ft/sec) RH: 10 min. in air moving 1 m/s (3.3 ft/sec)	Temp: 5 min. in air moving 1m/s (3.3 ft./sec) RH: 10 min. in air moving 1 m/s (3.3ft/sec)	Dependent on sensor	Temp: 5 min. in air moving 1m/s (3.3 ft./sec) RH: 10 min. in air moving 1 m/s (3.3ft/sec)	Dependent on sensor	N/A

A base system requires a HOBO Data Node, Receiver, and HOBOWare Pro software*

Common Specifications

- Range: Approx. 100 m (300ft.) depending on obstructions or interference
- Weight: 138 g (4.87 oz) with batteries
- Size: 96.5 x 108 x 28 mm (3.8 x 4.25x 1.1 in)
- Radio Power: 1.6 mW (2 dBm)
- Wireless data Standard: IEEE 802.15.4 2.4 GHz band

For more detailed specifications, please refer to individual device manuals FCC Certified. Check www.onsetcomp.com for the latest certification.



* HOBOWare Pro is included with the cost of the ZW Receiver.
**External T/RH cables included

Ordering Information

Data Loggers

Receiver & HOBOWare Pro Software	ZW-RCVR	\$199
Router only	ZW-ROUTER	\$149
Integrated Temperature	ZW-001	\$159
Integrated Temperature/RH	ZW-003	\$239
External- T/RH, (1) analog, (1) pulse	ZW-005	\$289
External- (4) analog	ZW-006	\$209
External- T/RH, (2) analog	ZW-007	\$289
External- (2) analog, (2) pulse	ZW-008	\$209

kWh***

WattNode Wye config 208/240	T-WNB-3Y-208	\$229
WattNode Wye 208/240 opt P3	T-WNB-3Y-208P	\$280
WattNode Delta/Wye config 208/240	T-WNB-3D-240	\$269
WattNode Delta/Wye config 480	T-WNB-3D-480	\$269
"B" Series Voltage Lead Set	A-WNB-LEADSET	\$70
Veris 1-phase, 300 Amp	T-VER-8051-300	\$642
Veris 3-phase, 800 Amp	T-VER-8053-800	\$849

Water Flow***

Water Flow Meter	T-MINOL-130	\$105
------------------	-------------	-------

kW**

3 Phase, 480V, 100 AMP	T-VER-8044-100	\$815
------------------------	----------------	-------

Gauge Pressure**†

100 psig	T-ASH-G2-100	\$190
200 psig	T-ASH-G2-200	\$190
500 psig	T-ASH-G2-500	\$190

Differential Air Pressure Transducer**†

.01-10.0 WC	T-VER-PXU-L	\$220
.01-10.0 WC	T-VER-PXU-X	\$195

Humidity**†

Duct-Mount RH/Temp	T-VAI-HMD-40Y	\$299
--------------------	---------------	-------

DC Current**†

0-200 Amp	T-VER-H970-200	\$205
-200 to 200 Amp	T-VER-971BP-200	\$299

Air Velocity Sensor**†

0.15-10 m/s	T-DCI-F900-L-P	\$319
0.15-5 m/s	T-DCI-F900-L-O	\$319
0.15-10 m/s	T-DCI-F900-S-P	\$235
0.15-5 m/s	T-DCI-F900-S-O	\$235

* Requires HOBOWare Pro software, see page 52 for details. HOBOWare includes USB interface cable.

** Requires input cable. See page 57 for compatibility.

*** Requires pulse input adapter. See page 57 for compatibility.

† Requires sensor power adapter (AC-SENS-1) See page 57 for compatibility.

Power adapters are supplied with ZW-RCVR, ZW-ROUTER, and all data node models.

Prices subject to change

HOBOWare Software is available for download via the web. Visit onsetcomp.com for details.

For more information, please call us at: 1-800-564-4377

Compressed Air Flow Meter**

1-80 SCFM	T-CDI-5200-10S	\$495
3-350 SCFM	T-CDI-5400-20S	\$629

Volatile Organic Compound (VOC)**†

0-10, 0-100, 0-1000 ppm	T-ION-TVOC	\$2995
-------------------------	------------	--------

Temperature Sensors

Air/Water/Soil Probe 0.3m (1ft)	TMC1-HD	\$32
Air/Water/Soil Probe 1.8m (6ft)	TMC6-HD	\$35
Air/Water/Soil Probe 6.1m (20ft)	TMC20-HD	\$40
Air/Water/Soil Probe 15.2m (50ft)	TMC50-HD	\$45
Stainless Steel Temp Probe 1.8m (6ft)	TMC6-HC	\$79
Pipe Temp 1.8m (6ft)	TMC6-HE	\$35

Split-core AC Current Sensors

0-20 Amps AC	CTV-A	\$90
0-50 Amps AC	CTV-B	\$90
0-100 Amps AC	CTV-C	\$90
0-200 Amps AC	CTV-D	\$115
0-600 Amps AC	CTV-E	\$115

CO₂**

Telaire CO ₂ /Temp Monitor	TEL-7001	\$465
---------------------------------------	----------	-------

AC Voltage Transmitters**

0 - 150 Volts AC	T-CON-ACT-150	\$139
0 - 300 Volts AC	T-CON-ACT-300	\$139

DC Voltage

0 - 2.5 Volts DC	CABLE-2.5-STEREO	\$9
0 - 5 Volts DC	CABLE-ADAP5	\$12
0 - 10 Volts DC	CABLE-ADAP10	\$12

Milliamps

4 - 20mA	CABLE-4-20MA	\$25
----------	--------------	------

Software

HOBOWare Pro Software (Windows®/MAC®)	BHW-PRO-CD	Included
---------------------------------------	------------	----------

Accessories

Sensor Power Adapter, 12 Volt DC @ 400mA	AC-SENS-1	\$29
--	-----------	------

HOBO Pro v2 Loggers



HOBO Pro v2 data loggers are weatherproof loggers that provide high accuracy temperature and relative humidity measurements.

Key Advantages:

- Weatherproof housing for use in outdoor or condensing environments
- High-accuracy measurements
- Replaceable RH sensor provides superior recovery from condensing conditions
- Small-diameter, external sensor versions for measurements in tight spaces
- Optic USB interface for fast and reliable download

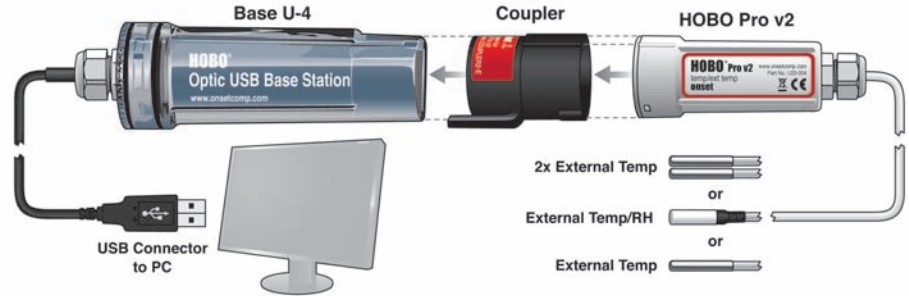

BASE-U-4 or U-DTW-1 is required with this logger (coupler is include). CE

Memory: 42,000 measurements
 Sample rate: 1 second to 18 hours, fixed rate or multiple logging intervals
 Battery life: 3 years (typical)—user-replaceable

Internal Temperature

Measurement range: -40° to 70°C (-40° to 158°F)
 Accuracy: ± 0.21°C from 0° to 50°C (0.36°F from 32° to 122°F)
 Resolution (12-bit): 0.02°@ 25°C (0.04°@ 77°F)
 Response time: 40 minutes (to 90% in airflow of 1 m/s)

Relative Humidity (RH)





Measurement range: 0 to 100% RH
 Accuracy: ± 2.5% typical, 3.5% maximum, from 10 - 90% RH
 Resolution (12-bit): 0.03% RH
 Response time: U23-001: 10 minutes (90% in airflow of 1 m/s; RH change only)
 U23-002: 5 minutes (90% in airflow of 1 m/s)

External Temperature

Measurement range: U23-002: -40° to 70°C (-40° to 158°F)
 U23-003 & U23-004: -40° to 100°C (-40° to 212°F);
 sensor tip and cable immersion in fresh water up to 50°C (122°F) for one year
 Accuracy: ± 0.2°C from 0° to 50°C (0.36°F from 32° to 122°F)
 Resolution (12-bit): 0.02°@ 25°C (0.04°@ 77°F)
 Response time: U23-002: 5 minutes (to 90% in airflow of 1 m/s)
 U23-003 & U23-004: 3 minutes (to 90% in airflow of 1 m/s)
 30 seconds (to 90% in water)

NIST-traceable temperature accuracy certification service available for all temperature sensors. (See page 72)

HOBO Pro v2 Comparison

	Internal Temp/RH	External Temp/RH	2x External Temp	Temp/External Temp
				
	U23-001*	U23-002*	U23-003	U23-004
	\$163	\$193	\$163	\$139
Number of Channels	2	2	2	2
Internal Sensors	Temperature	yes	--	yes
	Relative Humidity	yes	--	--
Integrated External Sensors	Temperature	--	yes	yes
	Relative Humidity	--	yes	--
Size	cm	10.2 x 3.8	10.2 x 3.8	10.2 x 3.8
	inches	4.0 x 1.5	4.0 x 1.5	4.0 x 1.5
	probe	--	1 cm (0.38 in) diameter probe on 1.8 m (6 ft) cable	0.5 cm (0.2 in) diameter probe on 1.8 m (6 ft) cable
Weight	grams	57	118	102
	ounces	1.5	3.1	2.7

* Replaceable RH Sensors available. Complete system requires logger, software, and base station or shuttle U-DTW-1.

Ordering Information

Data Loggers

HOBO Pro v2 Internal Temp/RH	U23-001	\$163
HOBO Pro v2 External Temp/RH	U23-002	\$193
HOBO Pro v2 External Temp	U23-003	\$163
HOBO Pro v2 Internal Temp/External Temp	U23-004	\$139

Software

HOBOWare Pro Software (Windows®/Mac®)	BHW-PRO-CD	\$99
HOBOWare Lite Software (Windows/Mac)	BHW-LITE-CD	\$45
Optic USB Base Station* with Couplers	BASE-U-4	\$115

Optional Communications and Accessories

HOBO U-Shuttle (requires Base Station)***	U-DT-1	\$260
HOBO Waterproof Shuttle with Couplers***	U-DTW-1	\$230
Solar Radiation Shield** (U23-001 only)	RS1	\$79
Assembled Solar Radiation Shield** (U23-001 only)	M-RSA	\$105
Solar Radiation Shield** U23-002, 003, 004	RS3	\$59
Mounting Clamp (for mounting U23-001 and 004 in RS1 or M-RSA)	U23-RS-CLAMPKIT	\$6
Replaceable RH Sensor for U23-001	HUM-RHPCB-1	\$65
Replaceable RH Sensor for U23-002	HUM-RHPCB-2	\$65
Replaceable RH Sensor Caps for U23-002 (5 pack)	HUM-RHCAP-2	\$48

* HOBO Waterproof Shuttle can also be used as a Base Station (See pages 70-71 for details on Data Shuttles and Base Stations).

** Accurate temperature and RH measurements in sun require a radiation shield. Use the RS1 or M-RSA for internal sensors and the RS3 for external sensors.

*** Requires HOBOWare Pro software, see page 52 for details.

Prices subject to change

HOBOWare software is available for download via the web. Visit onsetcomp.com for details.

HOBO Rain Gauge



The HOBO RG3 data logging rain gauge is a self-contained rainfall logger that includes an integrated data logger with a high-quality tipping-bucket rain gauge. The RG3's logger has a built-in temperature sensor and is on a cable so it can be used in an optional radiation shield for logging air temperature.

Key Advantages (RG3 and RG3-M models):

- Aluminum housing and 15.4 cm (6.06 in.) collector ring
- Field-proven design
- Logger can be moved into an optional radiation shield for logging air temperature
- Three mounting feet to use on flat, level surfaces (three screws included)
- Side bracket for mast mounting (hose clamps included)
- Self-emptying for continuous rainfall logging

RG3 Data Logging Rain Gauge

\$420

0.2 mm RG3-M
0.01 in RG3
15.2 cm diameter
x 25.7 cm high (6 x 10 in)
1.2 kg (2.5 lbs)

Rainfall

Range:	Up to 320 cm (RG3-M), up to 160 in (RG3)
Resolution:	0.2 mm (RG3-M), 0.01 in (RG3)
Time stamp resolution:	1 second
Calibration Accuracy:	±1.0% (up to 20 mm/hr [RG3-M], 1 in/hr [RG3])
Maximum rainfall rate:	12.7 cm (5 in.) per hour



Temperature

Range:	-20° to 70°C (-4° to 158°F)
Accuracy:	±0.47° @ 25°C (±0.85° @ 77°F); a solar radiation shield is required for temperature measurements
Resolution:	0.10° @ 25°C (0.18° @ 77°F)
Sample rate:	1 second to 18 hours, user-selectable

Memory

16,000 to 23,000 tips when recording rainfall only
25,000 to 30,000 total measurements when recording rainfall and temperature

Ordering Information

Data Logger

HOBO Rain Gauge	RG3 (0.01 in)	\$420
	RG3-M (0.2 mm)	\$420

Software

HOBOware Pro Software (Windows/Mac)	BHW-PRO-CD	\$99
HOBOware Lite Software (Windows/Mac)	BHW-LITE-CD	\$45
Pendant Base Station (required)	BASE-U-1	\$65
<i>HOBOware includes USB interface cable</i>		

Communications and Accessories

HOBO U-Shuttle (requires Base Station)*	U-DT-1	\$260
HOBO Waterproof Shuttle with Couplers**	U-DTW-1	\$230
Solar Radiation Shield	RS1	\$79

Prices subject to change

* Requires HOBOware Pro software. See page 52 for details.

** U-DTW-1 Data Shuttle can be used in place of base station (BASE-U-1)(See pages 70-71 for details).

HOBOware software is available for download via the web. Visit onsetcomp.com for details.

Complete system requires logger, software and base station.

Mounting the Rain Gauge

The HOBO Rain Gauge has provisions for mounting two ways: surface mounting (Figure 1) and pole mounting (Figure 2). Surface mounting is recommended where possible. Note: Figure 2 has logger deployed outside of rain gauge housing, mounted inside an optional solar radiation shield.

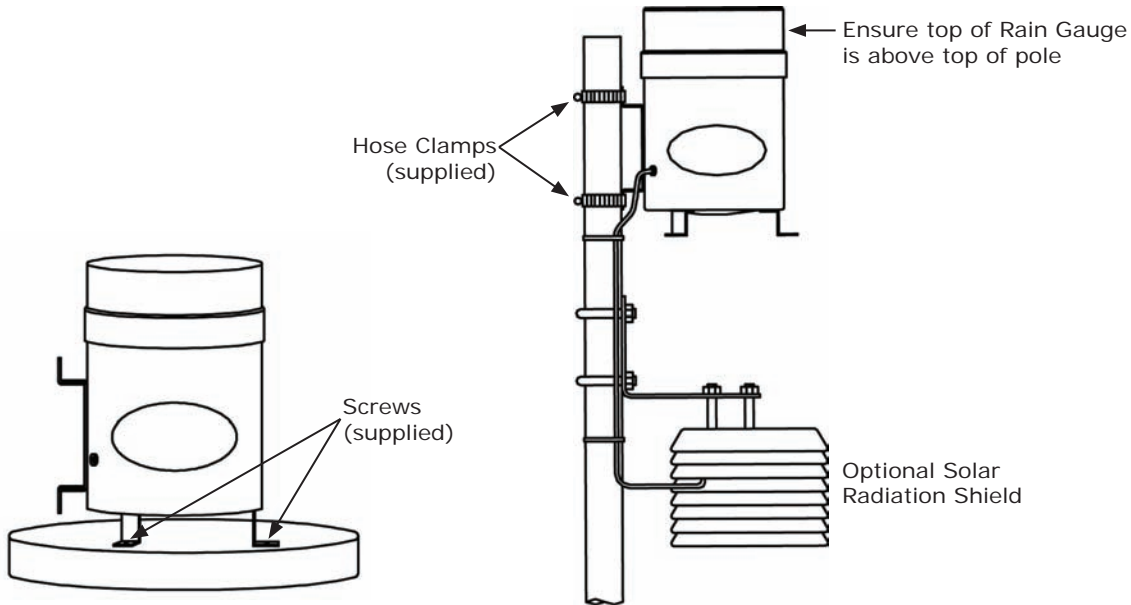

Figure 1: Surface mounting

Figure 2: Mast mounting

General Mounting Considerations

- The HOBO Rain Gauge housing **MUST** be mounted in a **LEVEL** position.
- A clear and unobstructed mounting location is necessary to obtain accurate rainfall readings. Tall objects can interfere with accurate rain measurements. It is recommended that you place the rain gauge away from the obstruction by a distance greater than three times the height of the obstruction. If that is not possible, raise the rain gauge as high as possible to avoid shedding.
- Avoid splashing and puddles. Be sure the gauge is high enough above any surface that rain will not splash into the top of the collector.
- Vibration can significantly degrade accuracy of the tipping bucket mechanism. In windy locations make sure that the bucket will be vibration-free.
- For maximum sensitivity in low-moisture environments you can remove the collector screen. This eliminates water retention on the screen which could evaporate before being measured. The tradeoff is that without the screen, debris can get into the funnel and clog the orifice.

HOBO Pendant Event



HOBO Pendant Event

\$95 UA-003-64

7.1 x 3.3 x 2.3 cm
(2.8 x 1.3 x 0.9 in)
Cable 1.8 m (6 ft)
50 g (1.7 oz)

The HOBO Pendant Event data logger is ideal for rainfall logging and connects to most standard tipping-bucket rain gauges to determine rainfall rates, times, and duration.

Key Advantages:

- Records tips or momentary contact closures and temperature
- Event-based data storage provides detailed data and efficient memory usage
- Stores over 16,000 tips (160 inches of rainfall with a 0.01 inch rain gauge)
- Includes scaling to inches, millimeters, or other units

Memory: Events only: 16K to 23K events
Events and temperature: 25K to 30K data points
Battery life: 1 year (typical) — user-replaceable

Weatherproof housing tested to NEMA 6 and IP67 

Rain Gauge Tips

External Event type: Relay contact closure or rain gauge "tips"
Connection: 2 m (6 ft) cable with 2-wire input
Resolution: 1.0 second
Maximum input frequency: 1 Hz

Temperature

Range: -20° to 70°C (-4° to 158°F)
Accuracy: ±0.47° @ 25°C (±0.85° @ 77°F); a solar radiation shield is required for temperature measurements
Resolution: 0.10° @ 25°C (0.8° @ 77°F)
Response time: 15 minutes (to 90% in airflow of 1 m/s)
Sample rate: 1 second to 18 hours, user-selectable

NIST-traceable temperature accuracy certification service available. (See page 72).

Complete system requires logger, software and base station.

Ordering Information

Data Logger

HOBO Pendant Event	UA-003-64	\$95
--------------------	-----------	------

Software

HOBOWare Pro Software (Windows/Mac)	BHW-PRO-CD	\$99
HOBOWare Lite Software (Windows/Mac)	BHW-LITE-CD	\$45
Pendant Base Station	BASE-U-1	\$65

HOBOWare includes USB interface cable

Optional Communications and Accessories

HOBO U-Shuttle (requires Base Station)*	U-DT-1	\$230
HOBO Waterproof Shuttle with Couplers* †	U-DTW-1	\$230
Solar Radiation Shield	RS1	\$79

* Requires HOBOWare Pro software, see page 52 for details.

Prices subject to change

† U-DTW-1 Data Shuttle can be used in place of base station (BASE-U-1) (See pages 70-71 for details).

HOBOWare software is available for download via the web. Visit onsetcomp.com for details.



HOBO U12 Industrial Logger
\$215 U12-008
 14.0 x 13.7 x 3.2 cm
 (5.50 x 5.38 x 1.25 in)

The HOBO U12 Industrial data logger provides 4 channels of input from a wide range of external sensors. The rugged enclosure is designed for use in harsh outdoor and industrial applications.

Key Advantages:

- Weatherproof enclosure (tested to NEMA 4x and IP67)
- Four channels of external input allow monitoring of multiple parameters

Memory: 43,000 measurements
 Sample rate: 1 second to 18 hours, user-selectable
 Battery life: 1-year (typical)—user-replaceable



External Input

External sensors for temperature, AC current, AC voltage, CO₂, 4-20mA, 0-2.5 VDC
 Input range: 0 to 2.5 volts DC
 Accuracy: ±2mV ±2.5% of absolute reading
 Resolution (12-bit): 0.6 mV
 Output power: 2.5 volts DC at 2 mA, active only during measurements
 Maximum recommended source impedance: 2.5k ohms

Ordering Information

Data Loggers		Temperature Sensors	
HOBO U12 Industrial Logger	U12-008	\$85	Air/Water/Soil Probe 0.3m (1ft) TMC1-HD \$32
kW**			Air/Water/Soil Probe 1.8m (6ft) TMC6-HD \$35
3 Phase, 450V, 100 AMP	T-VER-8044-100	\$815	Air/Water/Soil Probe 6.1m (20ft) TMC20-HD \$40
Gauge Pressure**†			Air/Water/Soil Probe 15.2m (50ft) TMC50-HD \$45
100 psig	T-ASH-G2-100	\$190	Stainless Steel Temp Probe 1.8m (6ft) TMC6-HC \$79
200 psig	T-ASH-G2-200	\$190	Pipe Temp 1.8m (6ft) TMC6-HE \$35
500 psig	T-ASH-G2-500	\$190	Split-core AC Current Sensors
Differential Air Pressure Transducer**†			0-20 Amps AC CTV-A \$90
.01-10.0 WC	T-VER-PXU-L	\$220	0-50 Amps AC CTV-B \$90
.01-10.0 WC	T-VER-PXU-X	\$195	0-100 Amps AC CTV-C \$90
Humidity**†			0-200 Amps AC CTV-D \$115
Duct-Mount RH/Temp	T-VAI-HMD-40Y	\$299	0-600 Amps AC CTV-E \$115
DC Current**†			CO₂**
0-200 Amp	T-VER-H970-200	\$205	Telaire CO ₂ /Temp Monitor TEL-7001 \$465
-200 to 200 Amp	T-VER-971BP-200	\$299	AC Voltage Transmitters**
Air Velocity Sensor**†			0 - 150 Volts AC T-CON-ACT-150 \$139
0.15-10 m/s	T-DCI-F900-L-P	\$319	0 - 300 Volts AC T-CON-ACT-300 \$139
0.15-5 m/s	T-DCI-F900-L-O	\$319	DC Voltage
0.15-10 m/s	T-DCI-F900-S-P	\$235	0 - 2.5 Volts DC CABLE-2.5-STEREO \$9
0.15-5 m/s	T-DCI-F900-S-O	\$235	0 - 5 Volts DC CABLE-ADAP5 \$12
Compressed Air Flow Meter**			0 - 10 Volts DC CABLE-ADAP10 \$12
1-80 SCFM	T-CDI-5200-10S	\$495	Milliamps
3-350 SCFM	T-CDI-5400-20S	\$629	4 - 20mA CABLE-4-20MA \$25
Volatile Organic Compound (VOC)**†			Software
0-10, 0-100, 0-1000 ppm	T-ION-TVOC	\$2995	HOBOware Pro Software (Windows®/Mac®) BHW-PRO-CD \$99
			HOBOware Lite Software (Windows®/Mac®) BHW-LITE-CD \$45
			Real-Time Alarm Software Plug-in* BHW-T-ALRM \$55
			Optional Communications
			HOBO U-Shuttle* U-DT-1 \$260
			USB to Ethernet Server SERVER-US-4 \$145

* Requires HOBOware Pro software, see page 52 for details. HOBOware includes USB interface cable.
 ** Requires input cable. See page 57 for compatibility.
 † Requires sensor power adapter (AC-SENS-1) See page 57 for compatibility.

Prices subject to change

HOBOware Software is available for download via the web. Visit onsetcomp.com for details.

Data Loggers/ Weatherproof



HOBOnode Wireless sensors combine field-proven HOBOnode reliability with the convenience of wireless.

HOBOnode sensors monitor temperature and soil moisture conditions and wirelessly transmit the data back to your computer. They enable you to view current conditions, receive alarm notifications, and log data on your PC without having to run cables through the field.

HOBOnode sensors are ideal for a broad range of applications, including agricultural research, crop and irrigation management, environmental studies, and greenhouse management.

Key Advantages:

- Sensors transmit current field conditions to your PC
- Accompanying software provides audible and visual alarm notifications
- All sensor data is logged to your PC
- Up to 6-mile transmission range (with HOBOnode Repeaters)
- Integrated solar panels keep batteries charged

For technical specifications and ordering information, please see page 31.

Wireless/Weatherproof

Fast, Easy Deployment

HOBOnode sensors can be deployed in a matter of minutes. The wireless sensors compact, integrated design makes it easy to deploy them in any type of field location. Sensors can be easily and quickly added to a HOBOnode network when additional data points are needed.

HOBOnode system components include a HOBOnode Sensor, Receiver, and free Utility Software.

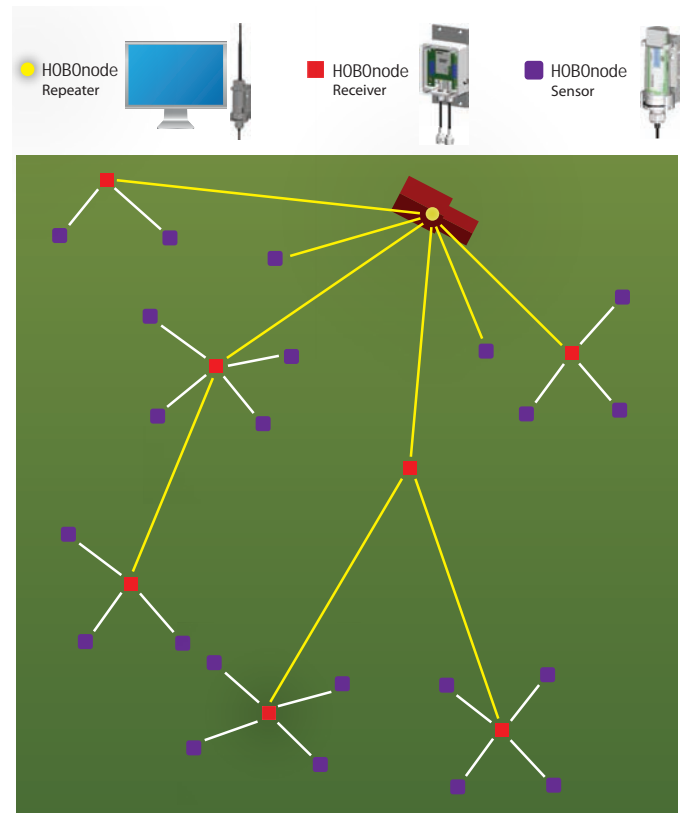
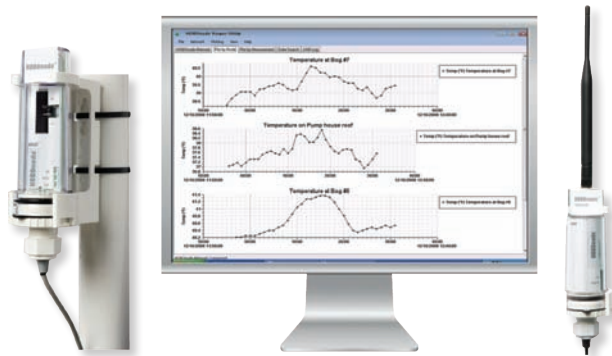

HOBOnode sensors can be used in a variety of network configurations, with and without the use of HOBOnode Repeaters as shown in the above topology.

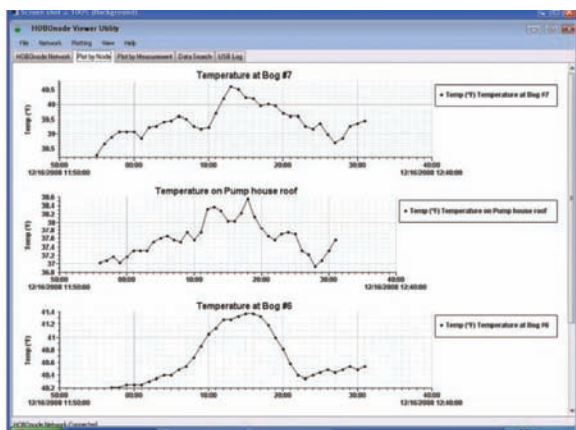

The HOBOnode Viewer Utility, which provides sensor set up, readout, and displays real-time graphs of temperature and soil moisture conditions. (The HOBOnode Viewer is a free download).

Real-time Monitoring

The system can also be configured to provide alarm notifications via cell phone or email, as well as audible alarms, when field conditions exceed set thresholds. Data can be exported for use in HOBOWare Pro, spreadsheets, and other programs.

HOBOnode Network

In many monitoring applications, it's important to have a complete network of sensors that can collect data from various locations throughout a site. HOBOnode sensors make it easy and affordable to set up a network, and add sensors when additional data points are needed.





HOBOnode Frost Alarm Starter System \$389 W-SYS-FR

- Protect your crops from frost with our HOBOnode Frost Alarm System.
- Get instant notifications sent to your cell phone, email, or PC when frost occurs.
- View real-time field conditions during frost events.
- Starter system includes HOBOnode Temperature and HOBOnode Receiver.



Up to 50 HOBOnode sensors can be used in a network.

Specifications

	 Temperature Sensor W-TMB	 Soil Moisture Sensor W-SMC
	\$179	\$230
Measurement Range	-40° to 100° C (-40° to 212°F)	0 to 1.00 m ³ /m ³ (0 to 100%) volumetric water content
Accuracy	± 0.22° from 0° to 50°C (± 0.4°F from 32° to 122°F)	± 3.1% (0.031) m ³ /m ³ in most soils, up to 8 ds/m
Resolution	0.025° at 25°C (0.045°F at 77°F)	0.07% (0.0007) m ³ /m ³
Response Time	3 minutes in air moving 1m/s 30 seconds in water	—
Sample Rate	1 reading per minute	
Battery Life	1 year typical without solar charging; 3 years typical with solar charging	
Size	16.5 cm x 5 cm; 3.7 m cable (6.5 in x 2 in; 12 ft cable to sensor)	16.5 cm x 5 cm; 5 m cable (6.5 in x 2 in; 16 ft cable to sensor)
Transmission Range	HOBOnode sensor to Receiver or Repeater: 420 m (1400 ft) with clear line-of-sight (LOS); 300 m (1000 ft) typical Repeater to Receiver or Repeater: 2.4 km (1.5 miles) with clear LOS; 2 km (1.25 miles) typical	
Wireless Standard	Based on IEEE 802.15.4, 2.4 GHz ISM band (license free worldwide)	
Environmental Rating	HOBOnodes and Receiver: NEMA 6P, IP68 Temperature sensor probe is rated for 1-year immersion in fresh water ≤ 50° C (122° F) Repeater: NEMA 4X	
HOBOnode Sensors and Repeaters Standard Operating Range	-20° to 50° C (-4° to 122°F)	
HOBOnode Sensors and Repeaters Operating Range with Optional Lithium Batteries	-40° to 50° C (-40° to 122° F)	
HOBOnode Receiver Operating Range	-40° to 50° C (-40° to 122°F)	
HOBOnode Receiver Communication to PC	1.8 m (6 ft) USB cable (can be extended with optional extension cable.)	
Maximum number of HOBOnode Sensors & Repeaters	50	
Maximum number of Repeaters in a series	4	
Repeater Battery Life	1 year typical without solar charging (6 months with >25 HOBOnodes) 2 years typical with solar charging	
Repeater Dimensions	43 cm (17 in) omni-directional antenna 30 cm x 40 cm (12 in x 16 in) directional antenna 8.9 x 11.4 x 5.4 cm (3.5 x 4.5 x 2.2 in) enclosure	



HOBOnode Wireless Temperature Sensor
\$179 W-TMB
 16.5 cm x 5 cm
 (6.5 x 2 in)
 Cable 3.7 m (12 ft)

- Measurement range is -40° to 100° C (-40° to 212° F)
- 1 reading per minute. Temperature probe can be used in air, soil or water.
- Can run for multiple years on solar power without having to replace batteries
- Transmission range: HOBOnode sensor to receiver: 420 m (1400 ft) with clear LOS; 300 m (1000 ft) typical



HOBOnode Wireless Soil Moisture Sensor
\$230 W-SMC
 16.5 cm x 5 cm
 (6.5 x 2 in)
 Cable 5 m (16 ft)

- 0 to 100% volumetric water content (m³/m³)
- 1 reading per minute
- Suitable for use in a wide variety of soils
- Can run for multiple years on solar power without having to replace batteries
- Transmission range: HOBOnode sensor to receiver: 420 m (1400 ft) with clear LOS; 300 m (1000 ft) typical



HOBOnode Receiver
\$220 W-RCVR-USB
 16.5 cm x 5 cm
 (6.5 x 2 in)
 Cable 1.8 m (6 ft)

- Receiver communication to PC: 1.8 m (6 ft) USB cable (Optional extension cables available)



HOBOnode Repeater
\$315 W-REPEATER
 (3.5 x 5.5 in) enclosure
 17 in omni-directional antenna
 (12 in x 16 in) directional antenna

- Transmission range: repeater to receiver or repeater: 2.4 km (1.5 miles) with clear LOS; 2 km (1.25 miles) typical
- Mast mounting kit include

Note: This repeater cannot be used in EU countries

Ordering Information

HOBOnode Sensors

HOBOnode Wireless Temperature Sensor ***	W-TMB	\$179
HOBOnode Wireless Soil Moisture Sensor	W-SMC	\$230
HOBOnode Receiver	W-RCVR-USB	\$220
HOBOnode Repeater	W-REPEATER	\$315
HOBOnode Wireless Frost Alarm Starter System (Includes temperature sensor, receiver, and software)	W-SYS-FR	\$389

Software

HOBOnode Viewer Utility Software
 (not compatible with Windows 7 or Mac) Free download at onsetcomp.com

Accessories

Solar Radiation Shield	RS3	\$59
Lithium AAA-2 pack	HRB-LI-AAA	\$10
<i>(For HOBOnode sensor and repeater operation below -20C - Lithium batteries do not support solar recharging feature)</i>		
Rechargeable replacement batteries	HRB-RCH-AAA	\$6
<i>(For the HOBOnode Sensors, Repeater, and Receiver)</i>		
USB active extension cable - 16 ft	CABLE-USB-EXT	\$24
<i>(Extension cable for use with HOBOnode Receiver only. Up to 5 of these can be used per Receiver.)</i>		

Tripod/Mast Accessories

Guy Wire Kit*	M-GWA	\$35
1/2 in Stake Kit*	M-SKA	\$25
2m Tripod with Mast**	M-TPB	\$50
1/4 in Stake Kit**	M-SKB	\$10

* Recommended for securing mounting poles in windy locations

** Recommended for the HOBOnode Repeater

*** Accurate temperature measurements in sunlight require a radiation shield.

We recommend 2.4 m x 3 cm (8 ft x 1¼ in) Schedule 40 PVC pipe for mounting the HOBOnode Sensors.
 (purchase through local building supply store)

Prices subject to change



HOBO Pendant data loggers are economical, waterproof temperature data loggers designed for a variety of short and long-term monitoring applications.

Key Advantages:

- Cost-effective temperature, light intensity, and acceleration loggers
- Waterproof housing for wet or underwater use
- Data readout in less than 30 seconds via fast Optic USB interface



BASE-U-1 is recommended with these loggers

HOBO Pendant Loggers

Memory: UA-001-08 — 6,500 measurements
 UA-001-64 — 52,000 measurements
 UA-002-08 — 3,500 temperature & light measurements
 UA-002-64 — 28,000 temperature & light measurements

Sample rate: 1 second to 18 hours, user-selectable

Battery life: 1-year (typical)—user-replaceable

Water Depth Rating: 30m from -20 to 20°C (100' from -40° to 68°F) CE

Temperature

Measurement range: -20° to 70°C (-4° to 158°F) in air
 -20° to 50°C (-4° to 122°F) in water

Accuracy: ± 0.54°C from 0° to 50°C (0.97°F from 32° to 122°F)

Resolution (10-bit): 0.1°C @ 25°C (0.2°F @ 77°F)

Response Time: 15 minutes (to 90% in airflow of 1 m/s)
 5 minutes (to 90% in water)

NIST-traceable temperature accuracy certification available. (See page 72).

Light Intensity

UA-002-08 & UA-002-64 only
 Designed for general purpose measurement of relative light levels

Range: 0-323,000 lumens/m² [0-30,000 footcandles (lumens/ft²)]

HOBO Pendant G

Memory: UA-004-64 — 64,000 1-axis measurement
 — 32,000 2-axes measurements
 — 21,333 3-axes measurements

Sample rate: 100 per second (100 Hz) to 18 hours, user-selectable

Battery life: 1-year (typical)—user-replaceable

Operating Range: -20° to 70°C (-4° to 158°F) in air
 -20° to 50°C (-4° to 122°F) in water CE

Acceleration

Measurement range: ± 3 G

Accuracy: ±2.5% FS @ 25°C (77°F)—Factory-calibrated

Resolution (8-bit): 0.02 G

Tilt/Motion





Measurement range: 0° to 180° from vertical

Accuracy: ±4.3° @ 90° to ±22.3° @ 0° and 180°

Resolution (8-bit): ±4.3° @ 90° to ±13° @ 0° and 180°

Data Loggers/ Waterproof

HOBO Pendant Comparison

		Temperature w/ Alarm Logger	Temperature w/ Alarm Logger	Temperature/ Light Logger	Temperature/ Light Logger	Acceleration/ Tilt/Motion
						
		UA-001-08	UA-001-64	UA-002-08	UA-002-64	UA-004-64
		\$42	\$59	\$42	\$59	\$75
Number of Channels		1	1	2	2	3
Internal Sensors	Temperature	yes	yes	yes	yes	--
	Light Intensity	--	--	yes	yes	--
	Acceleration	--	--	--	--	yes
Size	cm	5.8 x 3.3 x 2.3	5.8 x 3.3 x 2.3	5.8 x 3.3 x 2.3	5.8 x 3.3 x 2.3	5.8 x 3.3 x 2.3
	inches	2.3 x 1.3 x 0.9	2.3 x 1.3 x 0.9	2.3 x 1.3 x 0.9	2.3 x 1.3 x 0.9	2.3 x 1.3 x 0.9
Hole in mounting bail	mm	3.2	3.2	3.2	3.2	3.2
	inches	0.13	0.13	0.13	0.13	0.13
Weight	grams	18	18	18	18	18
	ounces	0.6	0.6	0.6	0.6	0.6

Complete system requires logger, software and base station or shuttle.

Ordering Information

Data Loggers

HOBO Pendant Temperature w/Alarm	UA-001-08	\$42
HOBO Pendant Temperature w/Alarm	UA-001-64	\$59
HOBO Pendant Temperature w/Light	UA-002-08	\$42
HOBO Pendant Temperature w/Light	UA-002-64	\$59
HOBO Pendant Acceleration/Tilt/Motion	UA-004-64	\$75

Software

HOBOWare Pro Software (Windows/Mac)	BHW-PRO-CD	\$99
HOBOWare Lite Software (Windows/Mac)	BHW-LITE-CD	\$45
Pendant Base Station**	BASE-U-1	\$65

Optional Communications and Accessories

HOBO U-Shuttle (requires Base Station)*	U-DT-1	\$260
HOBO Waterproof Shuttle with Couplers*	U-DTW-1	\$230
Solar Radiation Shield***	RS1	\$79

* Requires HOBOWare Pro software. See page 52 for details.

** HOBO Waterproof Shuttle or Optic USB Base Station (BASE-U-4) may be used instead of the Pendant Base Station (BASE-U-1) (See pages 70-71 for details).

*** Accurate temperature measurements in sunlight require a radiation shield.

Prices subject to change

HOBOWare software is available for download via the web. Visit onsetcomp.com for details.



HOBO Water Temp Pro v2 Logger
\$123 U22-001
 11.4 x 3.0 cm
 (4.5 x 1.19 in)
 hole in mounting bail
 6.3 mm (0.25 in)
 42 g (1.5 oz)



Protective Boot
BOOT-xxx

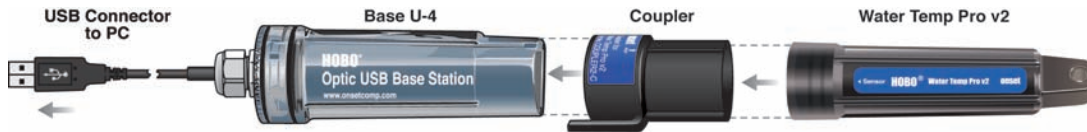

BASE-U-4 or U-DTW-1 is required with this logger (coupler is included)

Complete system requires logger, software and base station or waterproof shuttle.

The HOBO Water Temp Pro v2 data logger features 12-bit resolution and a precision sensor for $\pm 0.2^{\circ}\text{C}$ accuracy over a wide temperature range. Designed with a durable, streamlined case for extended deployment in fresh or salt water, the Water Temp Pro v2 is equipped with an Optic USB interface for data offload in the field, even when the data logger is wet.

Key Advantages:

- Research-grade measurements at an affordable price
- Waterproof to 120 meters (400 feet)
- Data readout in less than 30 seconds via fast Optic USB interface

Memory: 42,000 measurements
 Sample rate: 1 second to 18 hours, fixed - or multiple-rate up to 8 user-defined sampling intervals
 Battery life: 6 years (typical) — factory-replaceable



Measurement range: -40° to 70°C (-4° to 158°F) in air
 -40° to 50°C (-4° to 122°F) in water
 Accuracy: $\pm 0.2^{\circ}\text{C}$ from 0° to 50°C (0.36°F from 32° to 122°F)
 Resolution (12-bit): 0.02° @ 25°C (0.04° @ 77°F)
 Response time: 18 minutes (to 90% in airflow of 1 m/s)
 5 minutes (to 90% in water)

NIST-traceable temperature accuracy certification service available. (See page 72).

Ordering Information

Data Logger		
HOBOware Water Temp Prov2 Logger	U22-001	\$123
Software		
HOBOware Pro Software (Windows/Mac)	BHW-PRO-CD	\$99
HOBOware Lite Software (Windows/Mac)	BHW-LITE-CD	\$45
Optic USB Base Station with Couplers**	BASE-U-4	\$115
Optional Communications and Accessories		
HOBO U-Shuttle (requires Base Station)*	U-DT-1	\$260
HOBO Waterproof Shuttle with Couplers**, *	U-DTW-1	\$230
Solar Radiation Shield***	RS1	\$79
Protective Boot, black	BOOT-BLK	\$19
Protective Boot, white	BOOT-WHT	\$19

* Requires HOBOware Pro software. See page 52 for details
 ** HOBO Waterproof Shuttle can also be used as a Base Station. (See pages 70-71 for details on Data Shuttles and Base Stations)
 *** Accurate temperature measurement in sunlight requires a radiation shield. **Prices subject to change**

HOBOware software is available for download via the web. Visit onsetcomp.com for details.

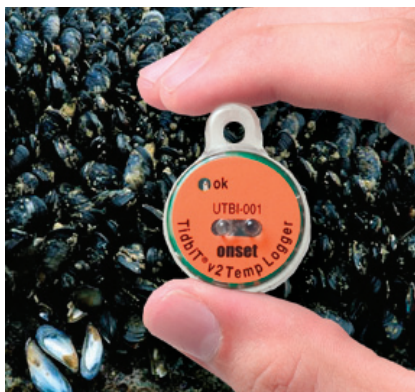

Tidbit v2 Temp Logger

\$133 UTBI-001

3.0 x 4.1 x 1.7 cm

(1.2 x 1.6 x 0.65 in)

hole in mounting bail 4.6 mm (0.19 in)

23 g (0.8 oz)



Protective Boot

5 for \$25

BOOT-TIDBIT-WH



Protective Boot

5 for \$25

BOOT-TIDBIT-BK

Onset's smallest data logger, the Tidbit v2 has 12-bit resolution and a precision sensor for $\pm 0.2^\circ\text{C}$ accuracy over a wide temperature range and is waterproof to 300m (1000 ft).

Key Advantages:

- Onset's smallest temperature logger
- Waterproof to 300 meters (1,000 feet)
- Data readout in less than 30 seconds via fast, optical USB interface

Memory: 42,000 measurements
 Sample rate: 1 second to 18 hours, fixed - or multiple-rate up to 8 user-defined sampling intervals
 Battery life: 5 years (typical) — non-replaceable



Measurement range: -20° to 70°C (-4° to 158°F) in air
 -20° to 30°C (-4° to 86°F) in water
 Accuracy: $\pm 0.21^\circ\text{C}$ from 0° to 50°C (0.36°F from 32° to 122°F)
 Resolution (12-bit): 0.02° @ 25°C (0.04° @ 77°F)
 Response time: 20 minutes (to 90% in airflow of 1 m/s)
 5 minutes (to 90% in water)

NIST-traceable temperature accuracy certification service available. (See page 72).



BASE-U-4 or U-DTW-1 is required with this logger (coupler is included)

Complete system requires logger, software and base station or waterproof shuttle.

Ordering Information

Data Logger

HOBO Tidbit v2 Temp	UTBI-001	\$133
---------------------	----------	-------

Software

HOBOWare Pro Software (Windows/Mac)	BHW-PRO-CD	\$99
HOBOWare Lite Software (Windows/Mac)	BHW-LITE-CD	\$45
Optic USB Base Station with Couplers*	BASE-U-4	\$115

Optional Communications and Accessories

HOBO U-Shuttle (requires Base Station)	U-DT-1	\$260
HOBO Waterproof Shuttle with Couplers*	U-DTW-1	\$230
Solar Radiation Shield**	RS1	\$79
Protective Boot 5-pack, black	BOOT-TIDBIT-BK	\$25
Protective Boot 5-pack, white	BOOT-TIDBIT-WH	\$25

* HOBO Waterproof Shuttle can also be used as a Base Station.
 (See pages 70-71 for details on Data Shuttles and Base Stations)

Requires HOBOWare Pro software. See page 52 for details

** Accurate temperature measurement in sunlight requires a radiation shield. **Prices subject to change**

HOBOWare software is available for download via the web. Visit onsetcomp.com for details.



HOBO Water Level Logger

\$495-\$795 U20-001-xx

2.46 cm diameter x 15 cm (0.97 x 5.9 in)

hole in mounting bail 6.3 mm (0.25 in)

Stainless: 210 g (7.4 oz)

Titanium: 140 g (4.8 oz)*

HOBO Water Level data loggers offer high accuracy at an affordable price, with no cumbersome vent tubes or desiccants to maintain. These data loggers are ideal for recording water levels and temperatures in shallow wells, streams, lakes and freshwater wetlands.

Key Advantages:

- Available in 4 depth ranges
- No-vent-tube design for easy and reliable deployment
- Available in stainless steel and titanium* versions
- Durable ceramic pressure sensor

Memory:	21,700 combined pressure and temperature measurements
Sample rate:	1 second to 18 hours, fixed- or multiple-rate up to 8 user-defined sampling intervals
Battery life:	5 years (typical) — factory-replaceable



Data Loggers/ Waterproof

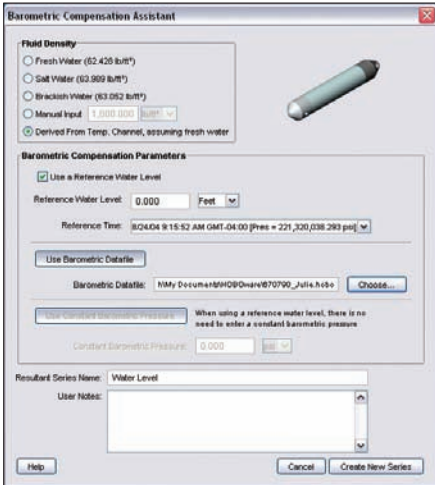

HOBOware software provides easy conversion to accurate water level readings, fully-compensated for barometric pressure, temperature and water density.

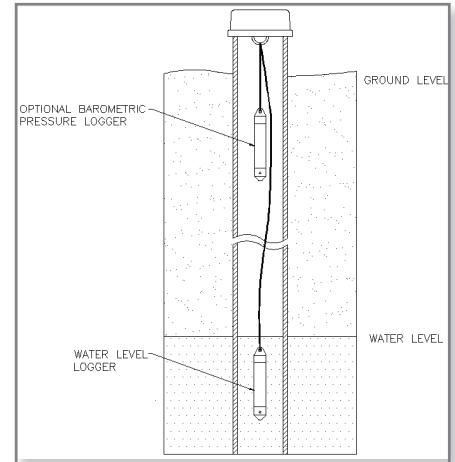

Simple wireline mounting makes it easy to hang logger in wells, hidden from vandals, with no vent cables to worry about.

- Includes calibration certificate of accuracy in accordance with NIST-traceable standards at three pressure points distributed throughout the range.
- **Sealed** housing ensures many years of trouble-free operation.
- Suitable for deployment in water or air; case materials resistant to fuels, solvents and lubricants.
- Use either an extra HOBO Water Level Logger, a HOBO U30 monitoring system, or import ASCII barometric data for barometric compensation (typically one barometric data set can be used with all water level loggers in that area).

NIST-Traceable temperature accuracy certification service available (See page 72).

****Titanium version recommended for saltwater deployment.***

HOBO Water Level Specifications					
Model	Range**	Factory Calibrated Range (0° to 40°C; 32° to 104°F)	Water Level Accuracy (Typical Error)***	Resolution	Burst Pressure**
U20-001-04 U20-001-04-Ti	0-4 m (0-13 ft) 0-145 kPa (0-21 psia)	69 to 145 kPa (10-21 psia)	±0.3 cm (0.01 ft) (±0.075% FS)	0.14 cm (0.005 ft)	310 kPa (45 psia) 18 m (60 ft) depth
U20-001-01 U20-001-01-Ti	0-9 m (0-30 ft) 0-207 kPa (0-30 psia)	69 to 207 kPa (10-30 psia)	±0.5 cm (0.015 ft) (±0.05% FS)	0.21 cm (0.007 ft)	310 kPa (45 psia) 18 m (60 ft) depth
U20-001-02	0-30 m (0-100 ft) 0-400 kPa (0-58 psia)	69 to 400 kPa (10-58 psia)	±1.5 cm (0.05 ft) (±0.05% FS)	0.41 cm (0.013 ft)	500 kPa (72.5 psia) 40.8 m (134 ft) depth
U20-001-03	0-76 m (0-250 ft) 0-850 kPa (0-123 psia)	69 to 850 kPa (10-123 psia)	±3.8 cm (0.125 ft) (±0.05% FS)	0.87 cm (0.028 ft)	1200 kPa (174 psia) 112 m (368 ft) depth

Temperature Specifications (all models)

Model	Range	Accuracy	Resolution (10-bit)	Response Time
All models	-20° to 50°C (-4° to 122°F)	±0.37° @ 20°C (0.67° @ 68°F)	0.1° @ 20°C (0.18° @ 68°F)	3.5 minutes (to 90% in water)
		±0.5° over -5° to 50°C (±0.9° over 23° to 122°F)	0.5° over -5° to 50°C (0.9° over 23° to 122°F)	

** **Depth range specifications are nominal values based on using the logger at sea level.**

*** **Using reference water level measurement and Barometric Compensation Assistant (included with HOBOware).**

Complete system requires logger, software, and base station.

Ordering Information

Data Loggers

Stainless steel ranges:	0-30'	U20-001-01	\$495
	0-100'	U20-001-02	\$495
	0-250'	U20-001-03	\$495
	0-13'	U20-001-04	\$495
Titanium	0-30'	U20-001-01-TI	\$745
	0-13'	U20-001-04-TI	\$745

Software

HOBOware Pro Software (Windows®/Mac®)	BHW-PRO-CD	\$99
Optic USB Base Station with Couplers*	BASE-U-4	\$115

HOBOware includes USB interface cable.

Optional Communications and Accessories

HOBO U-Shuttle (requires Base Station)*	U-DT-1	\$260
HOBO Waterproof Shuttle with Couplers**	U-DTW-1	\$230
1/16 in Teflon-coated stainless steel cable:		
feet 50	CABLE-1-50	\$59
300 feet	CABLE-1-300	\$260
Crimp Sleeve for cables (12-pack)	CABLE-1-CRIMP	\$29
Water Level Logger Carrying Case	U20-CASE-1	\$29

* Requires HOBOware Pro software, see page 52 for details.

** HOBO Waterproof Shuttle can also be used as a Base Station.

(See pages 70-71 for details on Data Shuttles and Base Stations).

Prices subject to change

HOBOware software is available for download via the web. Visit onsetcomp.com for details.



The Deluxe Kit

HOBO Water Level Kits combine high-accuracy water level measurements with out-of-the-box convenience. The Deluxe Kit includes a carrying case, two HOBO Water Level Loggers (one 13' and one 13', 30' or 100'), HOBOware Pro software, and a HOBO Waterproof Data Shuttle. The Starter Kit includes a HOBO Water Level Logger, HOBOware Pro Software, and an Optic USB Base Station. Available in 13', 30', and 100' depths.

Key Advantages:

- 0.01 foot accuracy, no bulky vent tubes
- Convenient connector-free data offload
- Fully-sealed housing ensures years of trouble-free operation



The Starter Kit

Data Loggers/ Waterproof

Ordering Information

Price	\$604	\$1,137	\$604	\$1,137	\$604	\$1,137
Product Number	KIT-S-U20-04	KIT-D-U20-04	KIT-S-U20-01	KIT-D-U20-01	KIT-S-U20-02	KIT-D-U20-02
HOBO Loggers Range	U20-001-04 0-13'	U20-001-04 Kit includes two 0-13'	U20-001-01 0-30'	U20-001-01 Kit includes one 0-13' and one 0-30'	U20-001-02 0-100'	U20-001-02 Kit includes one 0-13' and one 0-100'
Communications	BASE-U-4 base station	U-DTW-1 waterproof shuttle	BASE-U-4 base station	U-DTW-1 waterproof shuttle	BASE-U-4 base station	U-DTW-1 waterproof shuttle
Carrying Case	Not included	Included	Not included	Included	Not included	Included
HOBOware Pro Software	BHW-PRO-CD (included)					
Logger Housing	Stainless steel					

Prices subject to change

HOBOware software is available for download via the web. Visit onsetcomp.com for details.

HOBO Water Level Logger Benchmark Testing

The following highlights results from Onset's tests of the HOBO Water Level Logger and comparable loggers from two competitors. Vendors specify water level data loggers in different ways, and we felt it would be valuable to compare accuracy under identical test conditions. All loggers tested have a 30-ft measurement range. Our testing concluded that while the data loggers have similar accuracy at a fixed temperature, the HOBO Water Level Logger had significantly better accuracy when there were changing temperatures. See the detailed test results below.

Product	Specified Accuracy	Qualifications
HOBO Water Level Logger	±0.015 ft	over the factory-calibrated range 0° to 40° C (32 to 104 °F)
Competitor 1	±0.016 ft	with automatic temperature compensation, but no range specified
Competitor 2, Model A	±0.033 ft	over the factory-calibrated range 0° to 40° C (32 to 104 °F)
Competitor 2, Model B	±0.016 ft	over the factory-calibrated range 0° to 40° C (32 to 104 °F)

Accuracy at a Constant Temperature

We tested the water level loggers in a constant temperature environment to collect data for accuracy deviation over a range of depths. The HOBO Water Level logger performed well in this test. The worst case error for the HOBO logger was 0.013 feet, while the worst case errors for the competitive loggers were 0.016, 0.027 and 0.029 feet respectively.

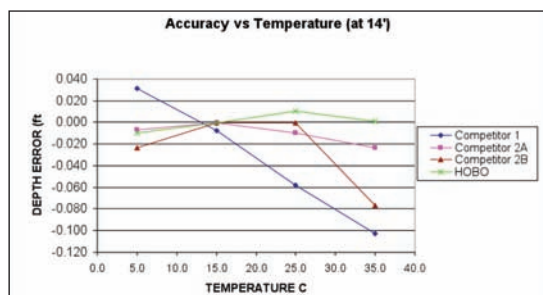
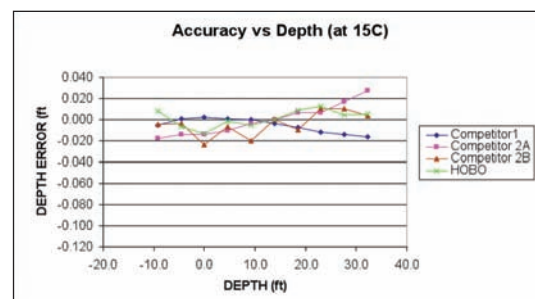

Temperature Compensation Accuracy

Accurate performance over temperature is particularly important for applications with varying water temperatures, such as streams, wetlands and tidal areas. We tested the water level loggers for accuracy across a range of temperatures. The worst case error for the HOBO Water Level logger in this test was 0.010 feet, while the worst case errors for the competitive loggers were 0.100, 0.023 and 0.077 feet respectively. The HOBO was within its accuracy specification across the full range of temperatures tested, measuring 10 times more accurately than the Competitor 1 logger at 35 °C.

Barometric Pressure Logger Accuracy

We tested the HOBO Water Level Logger's barometric pressure sensor against dedicated barometric pressure loggers from both competitors. The graph to the right shows the stability of the HOBO Water Level logger's sensor over the same range of barometric pressure as those dedicated loggers.

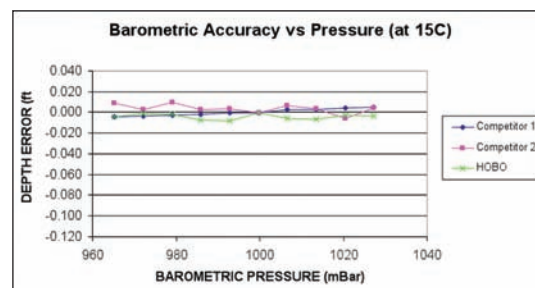

The HOBO U24 Conductivity Logger is a high-accuracy, cost-effective data logger for measuring conductance and temperature in streams, lakes, and other freshwater sources. Ideal for environmental impact studies, stormwater management, and water quality studies, the HOBO U24 is easy to deploy and maintain, and provides 0.01°C temperature accuracy with fast response.



Key Advantages:

- Non-contact capacitive sensor reduces measurement drift
- Provides easy access to sensor for cleaning and shedding air bubbles
- HOBOWare Pro software provides drift-compensation using calibration points from the start and end of each deployment and accurate conversion to specific conductance for the water type
- Optical interface provides high-speed, reliable data offload in wet environments
- Compatible with HOBO Waterproof Shuttle for easy and reliable data retrieval



Durable construction, easy maintenance

The HOBO U24 features a durable, non-corrosive housing that is designed for extended deployment in fresh water. Unlike conductivity loggers that are designed with electrode-based sensors, the HOBO Conductivity Logger features a non-contact capacitive sensor that makes it less susceptible to drift. This reduces the frequency of having to visit the field sites to offload data and/or take calibration readings.

The HOBO U24 also provides open access to the sensor for easy cleaning and better water flow. This, in turn, provides faster response times and fewer air bubbles. An optical communication interface eliminates the possibility of water-related damage and failures associated with mechanical plug-in connectors.

Powerful software

Onset's HOBOWare Pro software makes it easy to graph and analyze conductivity data, and offers a number of features that simplify conductivity monitoring projects. It provides a choice of methods for easy, accurate conversion of conductivity data to specific conductance for various water types. The software also makes it easy to combine data sets from multiple loggers, and offers one-click data export to Microsoft Excel and other programs. HOBOWare Pro also provides a simple approach for drift and fouling compensation using calibration points from the start and end of each deployment, and makes it easy to view and analyze data from multiple loggers on a single graph.

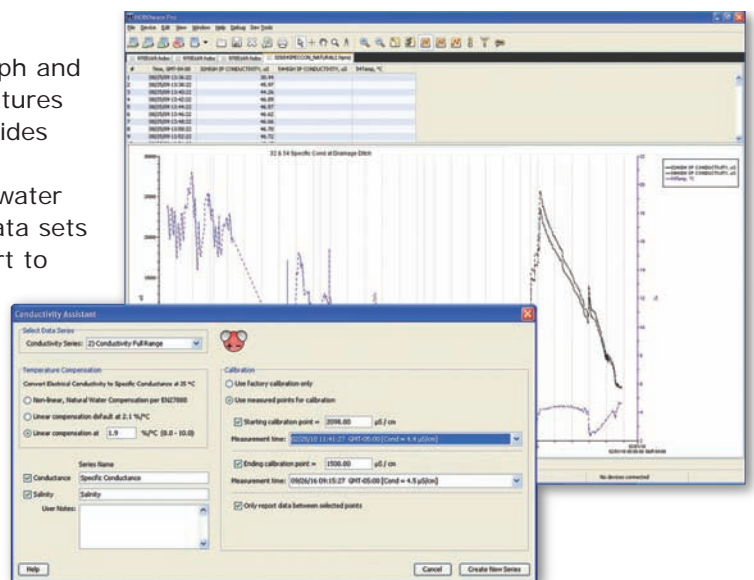

HOBO U24 Conductivity Logger Specifications



Conductivity
U24-001

Price	\$699	
Memory	18,500 temperature and conductivity measurements when using one conductivity range; 14,400 sets of measurements when using both conductivity ranges (64kbytes)	
Sample rate	1 second to 18 hrs, fixed or multiple-rate sampling with up to 8 user-defined sampling intervals	
Battery	3.6 Volt lithium battery	
Battery Life	3 years (at 1 minute logging), typical	
Maximum Depth	70 m (225 ft)	
Operating Range	0° to 50°C (32° to 122°F) -non-freezing	
Weight	193 gm (6.82 ounces), buoyancy in freshwater: -59.8 gm (-2.11 ounces) (it sinks)	
Size	3.18 cm diameter x 16.5 cm, with 6.3 mm mounting hole (1.25" diameter x 6.5", ¼" hole)	
Wetted Housing Materials	Delrin, epoxy, stainless steel, polypropylene, Buna-N O-ring, titanium pentoxide	
CE Compliant	Yes	
Sensor		
	Conductivity	Temperature
Calibrated Range	Low Range: 0 to 1,000 µS/cm; Full Range: 0 to 10,000 µS/cm	5° to 40° C (41 to 104° F)
Extended Range	Low Range: 0 to 2,500 µS/cm Full Range: 0 to 15,000 µS/cm	0° to 40° C (32 to 104° F)
Accuracy	3% of reading, or 5 µS/cm, whichever is greater	±0.1° C (±0.2° F)
Resolution	1 µS/cm	0.01° C (0.02° F)
Response time	1 second to 90% of change	

Ordering Information

Logger

HOBO Conductivity Logger	U24-001	\$699
--------------------------	---------	-------

Software

HOBOWare Pro Software (Windows/Mac)	BHW-PRO-CD	\$99
Optic USB Base Station with Couplers*	BASE-U-4	\$115

HOBOWare includes USB interface cable.

Communications

HOBO U-Shuttle (requires Base Station)	U-DT-1	\$260
HOBO Waterproof Shuttle with Couplers	U-DTW-1	\$230







* *HOBO Waterproof Shuttle can also be used as a Base Station.*
(See pages 70-71 for details on Data Shuttles and Base Stations).

Prices subject to change

*HOBOWare software is available for download via the web. Visit onsetcomp.com for details.
 Complete system requires logger, sensor and software.*

Data Logging Systems Comparison Chart

Comparison Chart

	HOBO Micro Station  H21-002	HOBO Remote Monitoring System			NRC  U30-NRC	HOBO Energy Logger  H22-001
		GSM  U30-GSM	Wi-Fi  U30-WIF	Ethernet  U30-ETH		
	\$220	\$850	\$770	\$675	\$399	\$315
Remote Communications	No	Yes	Yes	Yes	No	No
Internet access to real-time data	No	Yes	Yes	Yes	No	No
Enclosure	Weatherproof	Double weatherproof tamperproof	Double weatherproof tamperproof	Double weatherproof tamperproof	Double weatherproof tamperproof	Indoor
Fully-integrated, expandable communications	No	Yes	Yes	Yes	No	No
* Solar or AC power with rechargeable batteries	No	Yes*	Yes*	Yes*	Yes*	AC power option
Optional analog inputs with configurable sensor power	No	2	2	2	2	6
Smart Sensor compatible	Yes	Yes	Yes	Yes	Yes	Yes
# of inputs	4	5 expandable to 15	5 expandable to 15	5 expandable to 15	5 expandable to 15	3 module ports and 6 sensor inputs
USB connectivity	Requires Adapter	Yes	Yes	Yes	Yes	Requires Adapter
Operating Range	- 20° to 50° C standard - 40° to 70° C with optional Lithium batteries	- 20° to 40° C normal operation - 40° to 60° C extended range (limitations)	- 20° to 40° C normal operation - 40° to 60° C extended range (limitations)	- 20° to 40° C normal operation - 40° to 60° C extended range (limitations)	- 20° to 40° C normal operation - 40° to 60° C extended range (limitations)	- 20° to 50° C standard - 40° to 70° C with optional Lithium batteries
Battery Life Without Solar or AC power	1 year (typical) (4AA)	30 days (1hr connection interval)	30 days (1hr connection interval)	30 days (1hr connection interval)	6 months (typical)	1 year (typical) (8AA)
Data Storage Memory:	500,000 measurements	Unlimited in HOBOLink	Unlimited in HOBOLink	Unlimited in HOBOLink	500,000 measurements	512,000 measurements

* Solar panel or AC adapter purchased separately.

Prices subject to change

HOBO Micro Station



HOBO Micro Station

\$220 H21-002

8.9 x 11.4 x 5.4 cm
(3.5 x 4.5 x 2.125 in)
0.5 kg (1 lb)

The HOBO Micro Station offers reliable monitoring performance at industry-leading prices. Designed for stand-alone data logging applications, the 4-channel HOBO Micro Station accepts Onset's full suite of plug-and-play Smart Sensors, and is battery-powered for up to one year.

Key Advantages:

- Improved weatherproof enclosure for harsh environments
- Compact and low-cost with 4 sensor inputs
- Up to 2 DC voltage or 4-20mA input adapters

Common Specifications

Memory:	512K non-volatile data storage
Logging interval:	1 second to 18 hours, user-selectable
Battery life:	1 year (typical) — up to 10 sensors with 10-minute or longer logging interval
Operating range and battery type:	-20° to 50°C (-4° to 122°F) 4-AA alkaline batteries (standard) -40° to 70°C (-40° to 158°F) 4-AA lithium batteries (optional)
Sensor network cable length:	100 m (328 ft) maximum

HOBO Micro Station Ordering Guide

HOBO Micro Station Logger	H21-002	\$220	Sensor Mounting Accessories (continued)		
HOBO Micro Station Mast Mounting Kit	M-MKA	\$20	Weatherproof Connection Housing	S-EXT-CASE	\$21
HOBO Micro Station Grounding Wire	CABLE-HWS-G	\$16	(required for outside connections)		
(required for Wind Speed/Direction sensor or tripod mounting)			Half Cross Arm	M-CAB	\$45
Smart Sensor Ordering			(recommended for use with wind sensors)		
Temperature/RH:			Solar Radiation Shield	RS3	\$59
2 m cable	S-THB-M002	\$185	(for use with temperature and temp/RH sensors)		
8 m cable	S-THB-M008	\$195	Light Sensor Bracket	M-LBB	\$29
Temperature:			(for mounting PAR and solar radiation sensors on masts or flat vertical surfaces)		
2 m cable	S-TMB-M002	\$95	NDVI Light Sensor Bracket	M-NDVI	\$18
6 m cable	S-TMB-M006	\$105	Light Sensor Level	M-LLA	\$35
17 m cable	S-TMB-M017	\$120	(recommended for installing PAR and solar radiation sensors)		
Wind Speed/Direction	S-WCA-M003	\$540	Tripod/Masts and Accessories		
Wind Speed	S-WSA-M003	\$239	2 m Tripod with Mast		
R.M. Young Wind Sensor Adapters:			(M-SKB recommended)	M-TPB	\$55
Wind Monitor AQ	S-WCB-M003	\$150	Complete 2 Meter Tripod Kit	M-TPB-KIT	\$190
Marine Wind Monitor	S-WCC-M003	\$150	3 m Tripod with Mast		
Wind Sentry	S-WCD-M003	\$150	(M-SKA recommended)	M-TPA	\$150
Wind Alpine	S-WCE-M003	\$150	Complete 3 m Tripod Kit	M-TPA-KIT	\$275
Rain Gauge Aluminum: (.01 in)			1.5 m Mast	M-MPB	\$25
2 m cable	S-RGA-M002	\$420	3 m Mast	M-MPA	\$45
Rain Gauge Aluminum: (0.2 mm)			Guy Wire Kit	M-GWA	\$40
2 m cable	S-RGB-M002	\$420	1/4 in Stake Kit	M-SKB	\$11
Soil Moisture (ECHO-20)	S-SMA-M005	\$139	1/2 in Stake Kit	M-SKA	\$29
Soil Moisture (ECHO-10)	S-SMB-M005	\$139	Grounding Kit	M-GKA	\$45
Soil Moisture (ECHO-5)	S-SMC-M005	\$139	2 m Weatherproof Comm. Cable	CABLE-HWS2	\$30
Leaf Wetness	S-LWA-M003	\$110	17 m Weatherproof Comm. Cable	CABLE-HWS17	\$55
PAR	S-LIA-M003	\$220	Lithium Batteries, 4 pack	HWSB-LI	\$22
Silicon Pyranometer	S-LIB-M003	\$210	(does not provide protection from direct lightning strikes)		
Pulse Input Adapter:			Mast Level	M-MLA	\$13
-Electronic Switch	S-UCC-M00x	\$75	(recommended for installing masts or tripods)		
-Contact Closure	S-UCD-M00x	\$75	Software and Communications		
4-20mA Input Adapter	S-CIA-C14	\$85	HOBOware Pro Software	BHW-PRO-CD	\$99
0-5v DC Input Adapter	S-VIA-C14	\$85	USB-to-Serial-Cable	ADAPT-SER-USB	\$49
Water Flow	T-MINOL-130	\$105	U-Shuttle Data Transporter	U-DT-1	\$260
(requires pulse input adapter)					
Sensor Mounting Accessories					
Smart Sensor Extension Cables limited to 100 m of total cable length per logger (optional for use individually or combined).					
5 m length	S-EXT-M005	\$25			
10 m length	S-EXT-M010	\$30			
25 m length	S-EXT-M025	\$45			

Prices subject to change

See page 57 for additional sensors

HOBO U30 Remote Monitoring Systems



HOBO U30 systems provide real-time access to data from any web browser. Whether you're tracking climate conditions for field research, or measuring energy usage in a commercial building, HOBO U30 monitoring systems deliver accurate, dependable data right to your desktop.

Key Advantages:

- Web-based energy and environmental monitoring
- All electronics are housed within an industrial-grade, tamperproof enclosure
- Setup is quick and easy with plug-and-play sensors
- Measures a wide range of energy and environmental parameters
- GSM Cellular, Wi-Fi, Ethernet, direct USB options available

Industrial-grade dependability

HOBO U30 Remote Monitoring Systems deliver high accuracy measurements you can count on — in even the harshest environmental conditions. All at a fraction of the cost of competitive solutions.

Incorporating patented technology, all of the systems' electronics are housed within a rugged double-weatherproof, tamperproof enclosure. This provides twice the protection and ensures years of reliable monitoring performance.

Fast, easy deployment

The systems' plug-and-play architecture



enables any combination of Smart Sensors to be plugged in without extensive user programming, wiring, or calibration. Plug

in your sensors, connect the battery, and you're streaming real time data!

Learn More:

See specifications on page 45

See pricing on pages 46-47

See page 55 to learn more about HOBOLink, a web-based software platform that provides access to the HOBO U30 Remote Monitoring Systems.

Wide range of measurements

HOBO U30 systems measure and record a wide range of parameters including:

ENERGY

- AC Voltage
- AC Amps
- DC Amps
- kW
- kWh
- Gauge Pressure
- Differential Air Pressure
- CO₂
- Pulse Inputs from electric, or flow meters
- DC voltage
- 4-20mA

ENVIRONMENTAL

- Temperature
- Temp/RH
- Rainfall
- Soil Moisture
- Wind Speed & Direction
- Leaf Wetness
- PAR
- Solar Radiation
- Pulse Input
- Barometric Pressure

An optional analog sensor port provides sensor power with user-selectable warm-up time.

Available models include:

HOBO U30/GSM



- Built-in GSM cellular means no IT road-blocks
- Double weather proof, tamperproof enclosure

Starts at \$850

HOBO U30/Wi-Fi



- Ruggedized hardware, with integrated Wi-Fi
- Get notified of problems via cell phone or e-mail

Starts at \$770

HOBO U30/ETH



- Remote access to real-time data over Ethernet
- Simplifies facility-wide monitoring

Starts at \$675

HOBO U30/NRC



- Fast data offload via direct USB
- Optional analog inputs with sensor excitation

Starts at \$399

HOBO U30 Remote Monitoring Systems

Specifications	
GSM Wireless Communications	Quad-Band GSM/GPRS 850/900/1800/1900 MHz
Wi-Fi Wireless Communications	2.412 - 2.484 GHz IEEE 802.11 b/g
Ethernet	IEEE 802.11 b/g
Alarm Relay	Can be activated, deactivated or pulsed on user-defined sensor alarms. The relay can be configured as normally open or normally closed, (30V, 1A Max)
Alarm Notification Latency	Logging interval plus 2 to 4 minutes (typical)
Certifications	FCC Certified. Check www.onsetcomp.com for the latest certifications. 
Smart-Sensor Inputs	5 or 10
Data Channels	Maximum of 15 (some sensors use more than one data channel)
Sensor Network Cable Length	100 m (328 ft) maximum
Normal Operating Range	-20 to 40°C (-4 to 140°F)
Extended Operating Range	-40 to 60°C (-40 to 140°F) see battery life, Note: the GSM module will not communicate below -30°C (-22°F)
Local Communication	USB
Data Storage Memory	512K bytes local storage in non-volatile flash memory
Operational Indicators	LEDs show
Logging Interval	1 minute to 18 hours, user-specified
Station-to-Internet Upload Interval	10 minutes minimum, user-specified (depends on HOBOLink data service plan)
Power	An Onset solar panel (1.2w, 3w, 6w) or AC adapter is required
Battery Type	4 Volt, 10 Ahr, or 4.5 AHR Rechargeable Sealed Lead Acid
Battery Life	Typical 3-5 years depending upon conditions of use. Regular operation outside of the normal operating range will reduce battery life to 1-2 years.
Environmental Rating	Weatherproof; tested to NEMA 6
Dimensions	17.8 H x 11.7 D x 19.3 W cm (7.0 H x 4.6 D x 7.6 W inches)
Weight	2 kg (4.30 lbs.)
Mounting	Up to 1.63 in (4.1 cm) mast or wall mount
Enclosure Access	Hinged door secured by two latches, which can be further secured with user-supplied padlocks
Optional Analog Sensor Port	
Inputs	2 channels - User-configured as either 0-20 mA or 0-20 VDC
Sensor Power	Switched 12 VDC, up to 50 mA: user-selectable warm-up from 5 milliseconds to 2 minutes
Scaling	Linear scaling to user units
Accuracy	±0.25% full scale

Note: Some HOBO U30 models require high-speed internet access and a data plan with HOBOLink.com, an Onset-hosted and managed web server.

HOBO U30 Systems Ordering Guide

HOBO Remote Monitoring Systems with GSM Communications	GSM Cellular to Internet	U30-GSM	- ____	- __	- \$100	- ____	\$850
Sensor Port Options	No sensor port	000					included
	2-channel analog sensor port	VIA					\$89
Smart Sensor Input Options	5 smart sensor inputs	05					included
	10 smart sensor inputs	10					\$39
Battery Option	10 Ah rechargeable battery	S100					included
Global Data Service (work with AT&T and Mobile networks in the US; includes HOBOLink service)*	20 minute calling (1 min log)	303					\$576/1yr
	30 minute calling (1 min log)	304					\$420/1yr
	20 calls per day (1 min log)	305					\$300/1yr
T-Mobile-Only Plans (includes HOBOLink Service)*	10 minute calling (1 min log)	102					\$699/1yr
	1 call per day (15 min log)	105					\$240/1yr
AT&T-Only Plan (includes HOBOLink Service)*	10 minute calling (1 min log)	202					\$1020/1yr

See onsetcomp.com for the latest selection of service plans.

*Early termination fees apply. A \$200 fee will be assessed for terminating the service plan within 30 days. No refund will be applied for terminating the plan after 30 days.

HOBO Remote Monitoring Systems with Wi-Fi Communications**	Wi-Fi to Internet **	U30-WIF	- ____	- __	- ____	- ____	\$770
Sensor Port Options	No sensor port	000					included
	2-channel analog sensor port	VIA					\$89
Smart Sensor Input Options	5 smart sensor inputs	05					included
	10 smart sensor inputs	10					\$39
Battery Option	4.5 Ah rechargeable battery	S045					included
	10 Ah rechargeable battery required when using analog sensor port for sensor power	S100					\$19
HOBOLink Data Service	10 minute upload (1 sec log)	001					\$240/1yr
	10 minute upload (1 min log)	002					\$120/1yr
	1 hr uploads (5 min log)	003					included

See onsetcomp.com for the latest selection of service plans.

**Pre-N routers are Preliminary and should not be used with U30 Wi-Fi Remote Monitoring Systems.

HOBO Remote Monitoring Systems with Ethernet Communications	Ethernet to Internet	U30-ETH	- ____	- __	- ____	- ____	\$675
Sensor Port Options	No sensor port	000					included
	2-channel analog sensor port	VIA					\$89
Smart Sensor Input Options	5 smart sensor inputs	05					included
	10 smart sensor inputs	10					\$39
Battery Option	4.5 Ah rechargeable battery	S045					included
	10 Ah rechargeable battery required when using analog sensor port for sensor power	S100					\$19
HOBOLink Data Service	10 minute upload (1 sec log)	001					\$240/1yr
	10 minute upload (1 min log)	002					\$120/1yr
	1 hr uploads (5 min log)	003					included

See onsetcomp.com for the latest selection of service plans.

HOBO Remote Monitoring Systems without remote communications	No remote communication	U30-NRC	- ____	- __	- ____	- 000	\$399
Sensor Port Options	No sensor port	000					included
	2-channel analog sensor port	VIA					\$89
Smart Sensor Input Options	5 smart sensor inputs	05					included
	10 smart sensor inputs	10					\$39
Battery Options	4.5 Ah rechargeable battery	S045					included
	10 Ah rechargeable battery required when using analog sensor port for sensor power	S100					\$19
Data Plan	No data plan needed	000					N/A

Software (one required) HOBO U30 Shuttle U-DT-2 **\$260**
 HOBOware Pro (Windows/Mac) BHW-PRO-CD **\$99**

See next page for Sensors and Accessories

Power Source Options

1.2 Watt Solar Panel for sunny locations and/or locations with low data transfer requirements (readout every 2 hours or longer). SOLAR-1.2W **\$85**

3.0 Watt Solar Panel for moderately sunny locations and/or medium data transfer requirements (such as hourly readout). SOLAR-3W **\$129**

6.0 Watt Solar Panel for cloudy locations and/or high data transfer requirements (faster than 15 minute readouts). SOLAR-6W **\$149**

AC Power Adapter (120V, 60Hz) for locations with AC power available the adapter is not weatherproof. AC-U30 **\$35**

AC Power Adapter (EU) (240V, 50Hz) for locations with AC power available. The adapter is not weatherproof. AC-U30-EU **\$35**

Smart Sensors

Temperature		
2-m cable	S-TMB-M002	\$95
6-m cable	S-TMB-M006	\$105
17-m cable	S-TMB-M017	\$120
Temp/RH		
2-m cable	S-THB-M002	\$189
8-m cable	S-THB-M008	\$195
Wind Speed/Direction	S-WCA-M003	\$540
Wind Speed Sensor	S-WSA-M003	\$239
Rain Gauge: (.01 in)	S-RGA-M002	\$420
Rain Gauge: (0.2 mm)	S-RGB-M002	\$420
Soil Moisture (ECHO 20)	S-SMA-M005	\$139
Soil Moisture (ECHO 10)	S-SMB-M005	\$139
Soil Moisture (ECHO 5)	S-SMC-M005	\$139
Leaf Wetness	S-LWA-M003	\$110
PAR	S-LIA-M003	\$220
Solar Radiation	S-LIB-M003	\$210
Barometric Pressure	S-BPA-CM10	\$149
	S-BPB-CM50	\$249

Sensor Adapters

Pulse Input Adapter:		
-Electronic Switch	S-UCC-M00x	\$75
-Contact Closure	S-UCD-M00x	\$75

Sensors that require Pulse Input Adapter

kWh		
Wye config 208/240	T-WNB-3Y-208	\$229
Wye config opt P3	T-WNB-3Y-208-P	\$249
Delta/Wye config 208/240	T-WNB-3D-240	\$269
Delta/Wye config 480	T-WNB-3D-480	\$269
"B" Series Voltage Lead Set	A-WNB-LEADSET	\$70
Veris kWh		
1-phase, 300 Amp	T-VER-8051-300	\$642
3-phase, 800 Amp	T-VER-8053-800	\$849
Water Flow Meter	T-MINOL-130	\$105
Compressed Air Flow Meter	T-CDI-5200-10S	\$495
	T-CDI-5400-20S	\$629

Sensors that require Analog Sensor Port

Ashcroft Gauge Pressure		
100 psig	T-ASH-G2-100	\$190
200 psig	T-ASH-G2-200	\$190
500 psig	T-ASH-G2-500	\$190
Differential Air Pressure Transducer		
.01-10.0 WC	T-VER-PXU-L	\$220
.01-10.0 WC	T-VER-PXU-X	\$195
CO ₂ /Temp	TEL-7001	\$465
CO ₂ /Temp Port Cable	CABLE-2070	\$35
kW	T-VER-8044-100	\$815
Duct-Mount Temp/RH	T-VAI-HMD-40Y	\$299
DC Amperage	T-VER-H970-080	\$190
DC Current		
0-200 Amp	T-VER-H970-200	\$205
-200-200 Amp	T-VER-971BP-200	\$229

Air Velocity Sensor		
0.15-10 m/s	T-DCI-F900-L-P	\$319
0.15-5 m/s	T-DCI-F900-L-O	\$319
0.15-10 m/s	T-DCI-F900-S-P	\$235
0.15-5 m/s	T-DCI-F900-S-O	\$235
Compressed Air Flow Meter		
1-80 SCFM	T-CDI-5200-10S	\$495
3-350 SCFM	T-CDI-5400-20S	\$629

Sensors that require True RMS Adapter

TRMS Module	S-FS-TRMSA-D	\$105
AC Amperage		
0-5 Amp	T-MAG-SCT-005	\$55
0-20 Amp	T-MAG-SCT-020	\$55
0-50 Amp	T-MAG-SCT-050	\$55
0-100 Amp	T-MAG-SCT-100	\$55
0-200 Amp	T-MAG-SCT-200	\$55
0-600 Amp	T-MAG-SCT-600	\$65
AC Voltage		
0-150 Volt	T-MAG-SPT-150	\$79
0-300 Volt	T-MAG-SPT-300	\$79
0-600 Volt	T-MAG-SPT-600	\$79

Adapters for R.M. Young Wind Monitoring Sensors

Wind Monitor AQ	S-WCB-M003	\$150
Marine Wind Monitor	S-WCC-M003	\$150
Wind Sentry	S-WCD-M003	\$150
Wind Alpine	S-WCE-M003	\$150

Tripod/Masts and Accessories

2m Tripod with Mast		
(M-SKB recommended)	M-TPB	\$55
Complete 2 Meter Tripod Kit	M-TPB-KIT	\$190
3m Tripod with Mast		
(M-SKA recommended)	M-TPA	\$150
Complete 3 Meter Tripod Kit	M-TPA-KIT	\$275
3 m Mast	M-MPA	\$45
1.5 m Mast	M-MPB	\$25
Guy Wire Kit	M-GWA	\$40
1/4 in. State Kit	M-SKB	\$11
1/2 in. State Kit	M-SKA	\$29
Grounding Kit	M-GKA	\$45
<i>(does not provide protection from direct lightning strikes)</i>		
Mast Level	M-MLA	\$13
<i>(recommended for installing masts or tripods)</i>		
Half Cross Arm	M-CAB	\$45
<i>(recommended for use with wind sensors)</i>		
Solar Radiation Shield	RS3	\$59
<i>(for use with temperature and temp/RH sensors)</i>		
Light Sensor Bracket	M-LBB	\$29
<i>(for mounting PAR and solar radiation sensors on masts or flat vertical surfaces)</i>		
Light Sensor Level	M-LLA	\$29
<i>(recommended for installing PAR and solar radiation sensors)</i>		
NDVI Light Sensor Bracket	M-NDVI	\$18
Smart Sensor Extension Cables		
<i>(total cable length of all sensor cables is limited to 100 m (300 ft))</i>		
2-m length	S-EXT-M002	\$20
5-m length	S-EXT-M005	\$25
10-m length	S-EXT-M010	\$30
25-m length	S-EXT-M025	\$45
Weatherproof Connection Housing		
<i>(required for outside connections)</i>	S-EXT-CASE	\$21
1 to 2 Sensor Adapter	S-ADAPT-5	\$19
<i>This allows a single Smart Sensor input to branch to two Smart Sensors.</i>		
Cable Caddy	M-CDY	\$59
Smart Sensor Expansion Box	S-ADAPT-6	\$95

For more details on accessories, see page 50

Prices subject to change

HOBO Energy Logger



HOB0 Energy Logger

\$315 H22-001

15.4 x 9.4 x 5.1 cm
(6.06 x 3.69 x 2.00 in)
418.7 g (14.77 oz)

- Temperature
- Relative Humidity (RH)
- AC Current (True RMS)
- AC Voltage (True RMS)
- DC Current
- kW
- kWh
- Gauge Pressure
- Differential Air Pressure
- CO₂
- Pulse inputs from electric, or flow meters
- Other third-party sensors via 4-20mA/0-20 VDC

- Memory: Up to 512,000 measurements, number varies based on sensor selection
- Sample rate: 1 second to 18 hours, user-selectable
- Battery life: 1-year typical, based on 75mA sensor excitation, 1 second-warmup time, and 10-minute logging interval—user-replaceable, AC adapter (optional) 

- Ideal for**
- Building Commissioning
 - LEED Projects
 - Compressed Air Auditing
 - Energy Management & Facilities Management
 - HVAC/R Diagnostics
 - IAQ Projects
 - Chiller Optimization
 - M&V Projects
 - Performance Verification
 - Renewable Energy Installations

See page 49 for external sensors and attachment accessories.
See onsetcomp.com for application and specific system diagrams.

The HOB0 Energy Logger is a modular, re-configurable data logging system for energy and environmental monitoring applications.

Key Advantages:

- Onset's most flexible logger records up to 15 channels
- The HOB0 Energy Logger accepts up to three two-channel modules and six plug-and-play Smart Sensors (some sensors measure more than one parameter)
- Provides 12v excitation for third-party sensors
- Pre-configured Smart Sensors for fast setup
- Signal conditioning modules retain configurations until you change them, providing plug-and-play convenience for commonly used sensors
- Flexible power options include battery operation or AC power adapter

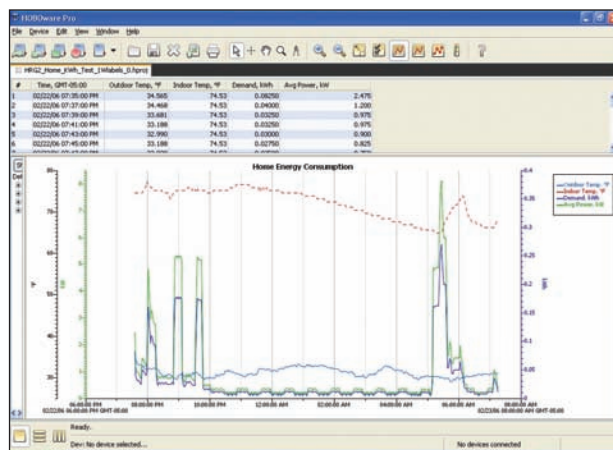

HOB0ware Pro Software provides easy logger launch, data readout, and plotting.

HOBO Energy Logger

HOBO Energy Logger Ordering Guide

HOBO Energy Logger	H22-001	\$315	Differential Air Pressure Transducer		
FlexSmart™ TRMS Module	S-FS-TRMSA	\$95	.01-10.0 WC	T-VER-PXU-L	\$220
FlexSmart™ Analog Module	S-FS-CVIA	\$89	.01-10.0 WC	T-VER-PXU-X	\$195
Pulse Input Adapter	S-UCC-M006	\$75	Vaisala Duct-Mount RH/Temp		
Sensors			Telaire CO ₂ /Temp	T-VAI-HMD-40Y	\$299
<i>Smart Sensors (plug-and-play, no module required).</i>			Cable to Module	TEL-7001	\$465
12-bit Temperature				CABLE-2070	\$35
2-m cable	S-TMB-M002	\$95	DC Current		
6-m cable	S-TMB-M006	\$105	0-200 Amp	T-VER-H970-200	\$205
17-m cable	S-TMB-M017	\$120	-200 to 200 Amp	T-VER-971BP-200	\$229
12-bit Temp/RH			Air Velocity Sensor		
2-m cable	S-THB-M002	\$189	0.15-10 m/s	T-DCI-F900-L-P	\$319
8-m cable	S-THB-M008	\$195	0.15-5 m/s	T-DCI-F900-L-O	\$319
			0.15-10 m/s	T-DCI-F900-S-P	\$235
			0.15-5 m/s	T-DCI-F900-S-O	\$235
WattNode kWh			Compressed Air Flow Meter		
<i>Pulse Input Adapter required.</i>			1-80 SCFM**	T-CDI-5200-10S	\$495
Wye config 208/240	T-WNB-3Y-208	\$229	3-350 SCFM**	T-CDI-5400-20S	\$629
Wye 208/240 opt	T-WNB-3Y-208-P	\$249	Volatile Organic Compound (VOC)		
Delta/Wye config 208/240	T-WNB-3D-240	\$269	0-10, 0-100, 0-1000 ppm	T-ION-TVOC	\$2995
Delta/Wye config 480	T-WNB-3D-480	\$269			
"B" Series Voltage Lead Set	A-WNB-LEADSET	\$70			
Veris kWh			Solar & Wind		
<i>Pulse Input Adapter required.</i>			Silicon Pyranometer	S-LIB-M003	\$210
1-phase, 300 Amp	T-VER-8051-300	\$642	(solar radiation)		
3-phase, 800 Amp	T-VER-8053-800	\$849	Wind Speed Sensor	S-WSA-M003	\$239
			Wind Speed &		
			Direction Sensor	S-WCA-M003	\$540
Pulse Input Sensor			Adapters for R.M. Young Wind Monitoring		
Water Flow Meter	T-MINOL-130	\$105	Wind Monitor AQ	S-WCB-M003	\$150
			Marine Wind Monitor	S-WCC-M003	\$150
			Wind Sentry	S-WCD-M003	\$150
			Wind Alpine	S-WCE-M003	\$150
True RMS Current and Voltage			Accessories		
<i>FlexSmart TRMS Module required (Part #S-FS-TRMSA).</i>			Mounting Feet Kit	A-H22-MOUNT-1	\$9
Magnelab Split-Core AC Current (also used with WattNode)			DIN Mount Kit	A-H22-DINMOUNT-1	\$19
0-5 Amp	T-MAG-SCT-005	\$55	AC power adapter	P-AC-1	\$29
0-20 Amp	T-MAG-SCT-020	\$55	Smart Sensor Extension Cables		
0-50 Amp	T-MAG-SCT-050	\$55	<i>(total cable length of all sensor cables is 100 m (300 ft)).</i>		
0-100 Amp	T-MAG-SCT-100	\$55	2-m length	S-EXT-M002	\$20
0-200 Amp	T-MAG-SCT-200	\$55	5-m length	S-EXT-M005	\$25
0-600 Amp	T-MAG-SCT-600	\$65	10-m length	S-EXT-M010	\$30
			25-m length	S-EXT-M025	\$45
Magnelab AC Voltage			1-to-2 Sensor Adapter***	S-ADAPT-5	\$19
0-150 Volt	T-MAG-SPT-150	\$79			
0-300 Volt	T-MAG-SPT-300	\$79	Software		
0-600 Volt	T-MAG-SPT-600	\$79	HOBOWare Pro Software		
			(Windows/Mac)	BHW-PRO-CD	\$99
Analog Input Sensors			Serial Interface Cable		
<i>These sensors require a FlexSmart Analog Module (Part #S-FS-CVIA).</i>			(Required)	CABLE-PC-3.5	\$10
Veris kW	T-VER-8044-100	\$815	USB Interface Cable	ADAPT-SER-USB	\$49
Ashcroft Gauge Pressure			Optional Communications		
100 psig	T-ASH-G2-100	\$190	HOBO U-Shuttle*	U-DT-2	\$260
200 psig	T-ASH-G2-200	\$190	Serial to Ethernet Server	SERVER-DS203	\$135
500 psig	T-ASH-G2-500	\$190			

Prices subject to change

*Requires HOBOWare Pro software, see page 52 for details.

**Can also be configured for pulse output

*** When used with Smart Sensor Extension Cables, this allows a single smart sensor input to branch to two Smart Sensors.

**Complete system requires logger, sensor and software.
HOBOWare Software is available for download via the web. Visit onsetcomp.com for details.**

Data Logging Systems - Accessories

- Tripods and masts provide convenient system deployment
- Sensor mounting accessories provide proper spacing for accurate measurements
- Kits available for ordering convenience



2 Meter Tripod \$55 M-TPB

- Height range: 1.72 to 2.13 m (5.6 to 7 ft)
- Mast diameter: 4.1 cm (1.63 in)
- Weight: 5.8 kg (12.8 lbs)

* M-GKA Grounding Kit is recommended when using tripods in exposed locations.

2 Meter Tripod Kit \$190 M-TPB-KIT

- 2-meter tripod (M-TPB)
- Grounding Kit (M-GKA)
- Guy Wire Kit (M-GWA)
- 1/2 in. Stake Kit (M-SKA) for guy wires
- 1/4 in. Stake Kit for tripod (M-SKB)
- Mast Level (M-MLA)



3 Meter Tripod* \$150 M-TPA

- Height range: 2.74 to 3.20 m (9 to 10.5 ft)
- Mast diameter: 4.1 cm (1.63 in)
- Weight: 12.7 kg (28 lbs)
- Maximum slope: 13 degrees for installation on moderately uneven ground

* M-GKA Grounding Kit is recommended when using tripods in exposed locations.

3 Meter Tripod Kit \$275 M-TPA-KIT

- 3-meter tripod (M-TPA)
- 1/2 in. Stake Kit (M-SKA) for guy wires
- Grounding Kit (M-GKA)
- Guy Wire Kit (M-GWA)
- Mast Level (M-MLA)



Cable Caddy \$59 M-CDY

- Extends sensor cable life by securing extra cables inside it
- Provides a convenient place to mount the S-BPB barometric pressure sensor
- Includes U-bolt for mast mounting and 4 cable ties

Light Sensor

Light Sensor Bracket

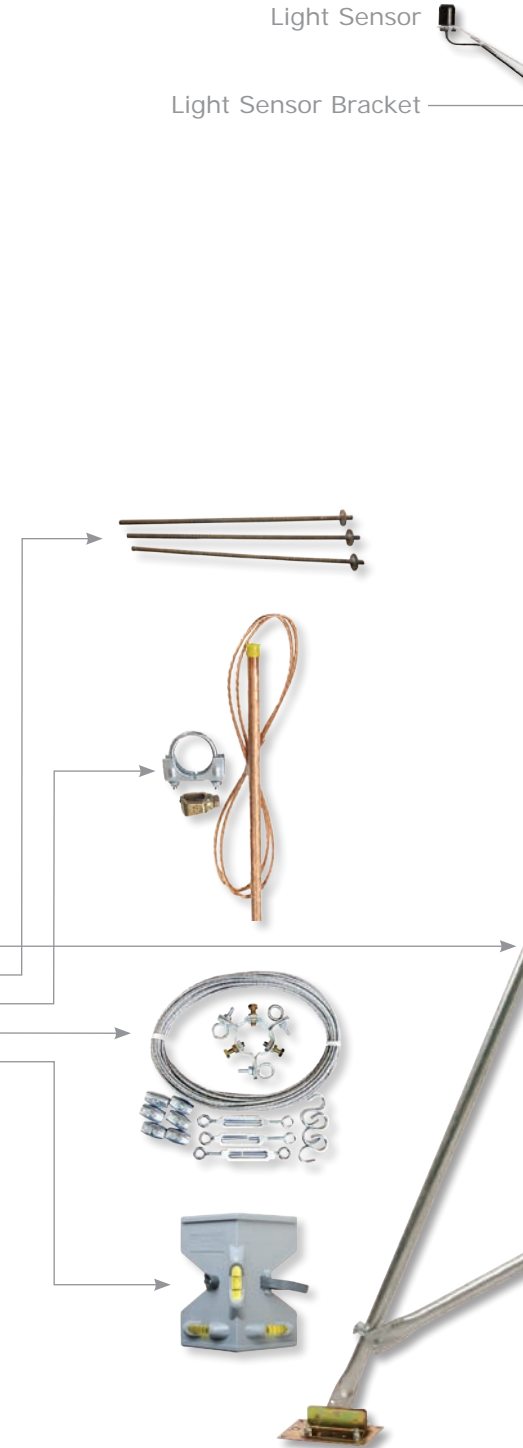

Data Logging Systems



Wind Direction

Wind Speed

Rain Gauge

Half Cross Arm

Solar Radiation Shield

Solar Panel

HOBOT U30

Cable Caddy

3 Meter Tripod with Mast



Light Sensor Bracket

\$29 M-LBB

Includes leveling screws and u-bolts for mast mounting

Solar Radiation Shield

\$59 RS3

Pre-assembled For S-THBs, S-TMBs includes clamp for mast mounting.



Half Cross Arm

\$45 M-CAB

Half cross arm (49 cm or 19.2 in)

NDVI Light Sensor Bracket

\$18 M-NDVI

Used to mount 2 PAR sensors and 2 solar radiation sensors for making NDVI measurements. Also requires M-LBB light sensor bracket



Light Sensor Level

\$35 M-LLA

Purchase one for use on any number of light sensors.

Smart Sensor Extension Cables

\$20-\$45 S-EXT-M0xx

2 m, 5 m, 10 m, 25 m (16 ft, 33 ft, 82 ft)

cable lengths available Use individually or connected together to optimize sensor placement. A weatherproof housing is required for outdoor connections (Part# S-EXT-CASE \$21). Limited to 100 meters per data logger.





HOBOWare Pro Software
\$99 BHW-PRO-CD

HOBOWare graphing and analysis software lets you view, graph and analyze data with point-and-click simplicity. You can easily setup your application in a matter of minutes, quickly read out and plot data, and export to spreadsheets for further analysis.

Key Advantages:

- Enhanced HOBOWare plotting preferences- font, line style, y-axis scaling, and saving settings
- Data Assistants and the Alarm and Readout Tool provide advanced data analysis and monitoring/notification of out-of-range conditions
- Available on CD or download via the web
- Presentation quality graphs
- Easy file management

Software

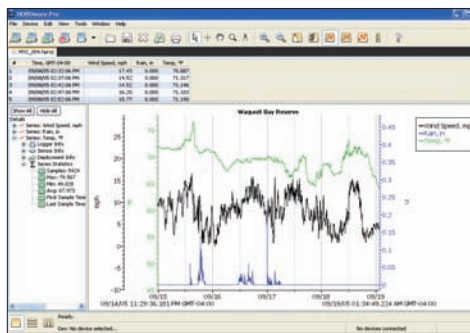

Powerful graphing features let you plot and filter data from multiple loggers or deployments.

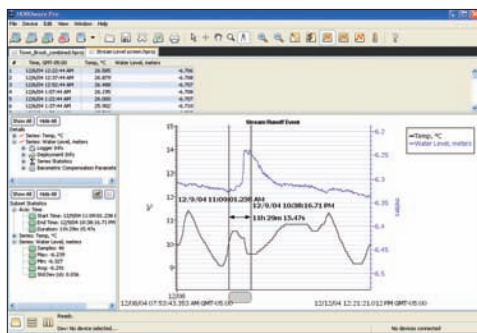

HOBOWare Pro's Subset Statistics tool calculates statistics over user-defined intervals.

HOBOWare Pro

30-Day FREE TRIAL

Visit onsetcomp.com for details

HOBOWare Pro vs HOBOWare Lite		
Features	HOBOWare Pro	HOBOWare Lite
Support for HOBO U-Series Loggers (except U30)	•	•
Support for HOBO Micro Station, H22, and U30	•	
Support for HOBO U-Shuttle and HOBO Waterproof Shuttle	•	
Launch supported loggers	•	•
Launch time-saving options	•	
Graphing and analysis with ability to view multiple data files on one graph	•	•
Readout and open-file time-saving options	•	
Filters to extract key series information such as daily min/max	•	•
Subset Statistics Tool	•	
Save (Project) Changes	•	•
Import ASCII text data	•	
Export ASCII text data	•	•
Check Logger Status and view current readings	•	•
Data Assistants for Water Level Barometric Compensation, Linear Scaling, Pulse Scaling, Conductivity and Growing Degree Day Assistance (included with software) & Grains per pound	•	
HOBOWare Setup Assistant	•	
Ability to add Data Assistants and plug-in Tools	•	
21 CFR Part 11 Secure Data Storage	•	
Bulk Export Tool	•	
Enhanced HOBOWare plotting preferences—font, line style, y-axis scaling, saving settings	•	
Ability to open multiple data files in one step	•	•
Series cropping - select timeframes for one or multiple data series	•	
Opening and plotting, exporting data files from previously unsupported (legacy H-series) loggers	•	
Additional toolbar icons for opening Filter and Add Graph Label windows	•	•
Ability to export directly to .xls (Excel) format	•	•
Option to submit a technical support request to Onset directly from the Help menu	•	•



HOBOWare Lite is Onset’s entry-level software for USB-based HOBOW data loggers, offering easy logger launch, readout, and data plotting.

Key Advantages:

- Easy logger launch, readout, and data plotting
- Ideal for users looking to save money and who don’t need all the features of HOBOWare Pro

HOBOWare Lite Software
\$45 BHW-LITE-CD

HOBOWare Pro for Windows System Requirements

- PC: Windows 7 (Pro, Ultimate and Home Premium), Windows XP Pro, Windows XP Home, Vista Business, Vista Home Premium
- Sun Java Runtime Environment (JRE) 1.6.
- One of the following Internet browsers (version number listed is the highest major version we tested): Safari 4, Firefox 3 or greater, Microsoft Internet Explorer 8.0.
- Minimum screen resolution of 1024 x 768
- 256+ colors
- 1.8 GHz single core*
- 1 GB*

HOBOWare Pro Mac System Requirements

- Mac: OS X Versions 10.5.x and 10.6.x.
- Sun Java Runtime Environment (JRE) 1.6. Please note that version 1.6, also known as Java 6, is officially supported on OS X only on Intel Core 2 Duo processors
- One of the following Internet browsers (version number listed is the highest major version we tested): Safari 4, Firefox 3 or greater, Microsoft Internet Explorer 8.0.
- 1024 x 768 display resolution (minimum)
- 256+ colors
- 1.8 GHz single core*
- 1 GB*

* HOBOnode users require up to 2.9 GHz dual core and 3GB RAM. See onsetcomp.com for details.

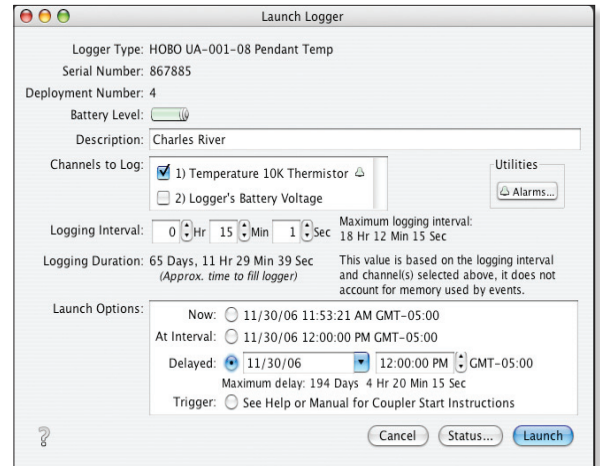

Easy logger setup - select launch parameters and go!

Software

Ordering Information

Software

HOBOWare Pro Software (Windows/Mac)	BHW-PRO-CD	\$99
HOBOWare Lite Software (Windows/Mac)**	BHW-LITE-CD	\$45
USB Serial Adapter (for H Series)	ADAPT-SER-USB	\$49
Serial Interface Cable (for H Series)	CABLE-PC-3.5	\$10

HOBOWare includes USB interface cable.

** HOBOWare Lite does not support Data Shuttles.

Prices subject to change

HOBOWare software is available for download via the web. Visit onsetcomp.com for details.

Alarm & Readout Tool



The Alarm & Readout Tool is a plug-in tool for HOBOWare Pro software. It automatically notifies you via cell phone text messages or email when temperature, humidity and other specified conditions exceed user-defined limits. It also enables you to automatically offload and store data from networked HOBOWare data loggers onto a centralized computer.

Key Advantages:

- Alarm notification via cell phone text message, pager or e-mail when conditions exceed user-defined limits
- User-defined delay filters out false alarms from momentary events
- Alarm notification when batteries or available memory get low, or when logger connection is broken
- Displays current logger readings

Alarm and Readout Tool System Requirements

Parent Software

- HOBOWare Pro

Logger Ethernet Communication Requirements

- **HOBOWare U10, U12, and U14 Loggers:** Each logger requires its own USB port on the computer or can connect remotely through an Ethernet network using a Keyspan USB Server (part# SERVER-US-4). Keyspan server connection limit is 12 remote USB ports at a time. Each logger requires a USB cable (CABLE-USBMB).
- **HOBOWare U9 and U11 Loggers:** Same requirements as above, but alarms are not supported for Event or State inputs.
- **HOBOWare Energy Logger**
Each logger requires its own serial port on the computer or can connect remotely through an Ethernet network using a Tibbo Serial-Ethernet Server (part #SERVER-DS203). Each logger requires its own Tibbo Server and serial interface cable (part #CABLE-PC-3.5).

Notification and Storage Requirements

To receive alarm notifications via cell phone, pager, or e-mail, you will need a continuous Internet connection with e-mail or SMTP service to send notifications, and one or more of the following:

- Text-message-enabled cell phone (to receive cell phone notifications)
- Alphanumeric pager (to receive pager notifications)
- E-mail account (to receive e-mail notifications)
- Local storage or FTP site (to store readout data)

Ordering Information

Software

HOBOWare Pro Software (Windows/Mac)	BHW-PRO-CD	\$99
Real-Time Alarm Software Plug-in	BHW-T-ALRM	\$55
<i>HOBOWare includes USB interface cable</i>		

Optional Communications

Tibbo Serial-Ethernet Server	SERVER-DS203	\$135
Keyspan USB-Ethernet Server	SERVER-US-4	\$145
USB Interface Cable	CABLE-USBMB	\$10
<i>One required for each HOBOWare U-Series Logger</i>		
Serial Interface Cable	CABLE-PC-3.5	\$10
<i>One required for each HOBOWare Energy Logger</i>		
USB Interface Cable*	ADAPT-SER-USB	\$49
<i>includes CABLE-PC-3.5</i>		
<i>Required for connecting the Micro Station to a computer USB port.</i>		

*USB Serial Adapter is not supported for use with Keyspan USB (SERVER-US-4).

Prices subject to change

HOBOWare Software is available for download via the web. Visit onsetcomp.com for details.



HOBOLink is a web-enabled software platform designed for HOBO U30 Remote Monitoring Systems (GSM/WiFi/ETH models). It allows you to easily access current and historical data, set alarm notifications and relay activations, and manage and control your HOBO U30 Remote Monitoring Systems.

Key Advantages:

- 24/7 web access to your data
- Customize your data display
- Verify U30 system status remotely
- Set up and manage alarm notifications over the web



Powerful web-based access to HOBO U30 Remote Monitoring Systems

Customize your display Easily configure your data display settings. Create a single screen that displays key measurement data and trends for most of your HOBO U30 systems.

Easily access your data In addition to viewing your data in web-based graphs, you can quickly download your HOBOLink data in both .txt and HOBOWare .dtf data file formats for detailed analysis.

Get notified Set up and manage alarm notifications through the web. HOBOLink will send a text message to your phone and email to your computer when conditions exceed set thresholds or if there is a sensor failure or low battery.

Security HOBOLink provides you with password-protected accounts and a 128-bit encrypted connection. You can keep your data private or make it accessible to others through the "Public Access" features.

Verify system status Use HOBOLink to keep a close eye on remotely deployed HOBO U30 systems. Check system status in real time to confirm the system is operating and communicating as it should.

Software

Ordering Information

HOBO U30/GSM Global Data Service (work with AT&T and Mobile networks in the US; includes HOBOLink service)	20 minute calling (1 min log)	SP-303	\$576/1yr
	30 minute calling (1 min log)	SP-304	\$420/1yr
	20 calls per day (1 min log)	SP-305	\$300/1yr
T-Mobile-Only Plans (includes HOBOLink Service)	10 minute calling (1 min log)	SP-102	\$699/1yr
	1 call per day (15 min log)	SP-105	\$240/1yr
AT&T-Only Plan (includes HOBOLink Service)	10 minute calling (1 min log)	SP-202	\$1020/1yr
HOBO U30/WiFi HOBOLink Data Service	10 minute upload (1 sec log)	SP-001	\$240/1yr
	10 minute upload (1 min log)	SP-002	\$120/1yr
	1 hr uploads (5 min log)	SP-003	included
HOBO U30/Ethernet HOBOLink Data Service	10 minute upload (1 sec log)	SP-001	\$240/1yr
	10 minute upload (1 min log)	SP-002	\$120/1yr
	1 hr uploads (5 min log)	SP-003	included
Software (one required)	HOBOWare Pro (Windows/Mac)	BHW-PRO-CD	\$99

See onsetcomp.com for the latest selection of service plans.

Prices subject to change

Sensor Compatibility Guide

Weather/Environmental Sensors

Measurement	Part#	Price	U30	H21-002	H22-001	U12-008	Notes
Barometric Pressure	S-BPB-CM50	\$249	x	x	◆		
Leaf Wetness	S-LWA-M003	\$110	x	x	◆		
Solar Radiation (Silicone Pyranometer)	S-LIB-M003	\$210	x	x	◆		
Photosynthetically Active Radiation (PAR)	S-LIA-M003	\$220	x	x	◆		
Rain (0.01") Aluminum	S-RGA-M002	\$420	x	x	◆		
Rain (0.2mm) Aluminum	S-RGB-M002	\$420	x	x	◆		
Soil Moisture - EC20	S-SMA-M005	\$139	x	x	◆		
Soil Moisture - EC10	S-SMB-M005	\$139	x	x	◆		
Soil Moisture - EC5	S-SMC-M005	\$139	x	x	◆		
Temperature	S-TMB-M0xx	\$95-\$120	x	x	x		
Temperature	TMCX-HD	\$29-\$42				x	
Relative Humidity & Temperature	S-THB-M00x	\$189-\$195	x	x	x		
Wind Speed	S-WSA-M003	\$239	x	x	◆		
Wind Speed & Direction	S-WCA-M003	\$540	x	x	◆		
Adapters for R.M. Young Wind Sensors	S-WCx-M00x	\$150	x	x	◆		
Analog and Digital Adapters for Connecting Sensors							
0-5 Volt DC	S-VIA-CM14	\$85	x	x	x		Provides 2.5VDC, 1mA Excitation
0-10 Volt DC Input Cable	CABLE-ADAP10	\$12				x	Does not provide Excitation Voltage
0-5 Volt DC Input Cable	CABLE-ADAP5	\$12				x	Does not provide Excitation Voltage
0-2.5 Volt DC Input Cable	CABLE-2.5-STEREO	\$9				x	Does not provide Excitation Voltage
4-20mA	S-CIA-CM14	\$85	x	x	x		Does not provide Excitation Voltage
4-20mA Input Cable	CABLE-4-20mA	\$25				x	
Pulse Input Adapter electronic	S-UCC-M00x	\$75	x	x	x		
Pulse Input Adapter contact closure	S-UCD-M00x	\$75	x	x	x		
U30 Built in Analog Input Port (2 inputs)	VIA	\$89	x				Provides 12VDC, 50mA Excitation

- ◆ These sensors are not generally used with the H22-001, but they are compatible as long as the H22 is in an indoor environment
- * Call for pricing and availability

Prices subject to change

Sensor Compatibility Guide

Energy Sensors

			Required Items										
Measurement	Part#	Price	U30	H22	U12	ZW	Excitation Required	U30	H22-01	H21-002	U12	ZW	
AC Voltage Transmitters	T-CON-ACT-xxx	\$139				CABLE-4-20mA					x	x	
Split-Core AC Current Sensors up to 600 AMP	CTV-x	\$90-\$115									x	x	
TRMS AC Amperage	T-MAG-SCT-xxx	\$55-\$65	S-FS-TRMSA-D	S-FS-TRMSA				x	x				
TRMS AC Voltage	T-MAG-SPT-xxx	\$79	S-FS-TRMSA-D	S-FS-TRMSA				x	x				
Air Velocity	T-DCI-F900-S-x	\$235	Built in VIA	S-FS-CVIA		CABLE-ADAP5 & AC-SENS-1	12 VDC, 70mA	x	x		x	x	
Air Velocity	T-DCI-F900-L-x	\$319	Built in VIA	S-FS-CVIA		CABLE-ADAP5 & AC-SENS-1	12 VDC, 70mA	x	x		x	x	
Carbon Dioxide	TEL-7001	\$465	Built in VIA & CABLE-2070	S-FS-CVIA & CABLE-2070		CABLE-CO2		x	x		x	x	
Compressed Air Flow Meter	T-CDI-5200-10S	\$495	Built in VIA	S-FS-CVIA		CABLE-4-20mA		x	x	x	x	x	
Compressed Air Flow Meter	T-CDI-5400-20S	\$629	Built in VIA	S-FS-CVIA		CABLE-4-20mA		x	x	x	x	x	
DC Amperage -200 to 200 AMP	T-VER-971BP-200	\$229	Built in VIA	S-FS-CVIA		CABLE-4-20mA & AC-SENS-1	12 VDC, 35mA	x	x		x	x	
DC Amperage 0-200 AMP	T-VER-H970-200	\$205	Built in VIA	S-FS-CVIA		*CABLE-ADAP5 & AC-SENS-1	12 VDC, 35mA	x	x		x	x	
Differential Air Pressure	T-VER-PXU-L	\$220	Built in VIA	S-FS-CVIA		*CABLE-ADAP5 & AC-SENS-1	12 VDC, 35mA	x	x		x	x	
Differential Air Pressure	T-VER-PXU-X	\$195	Built in VIA	S-FS-CVIA		*CABLE-ADAP5 & AC-SENS-1	12 VDC, 35mA	x	x		x	x	
Gauge Pressure	T-ASH-G2-xxx	\$190	Built in VIA	S-FS-CVIA		CABLE-ADAP5 & AC-SENS-1	12 VDC, 5mA	x	x		x	x	
Kilowatt Hours (kWh) 1 phase, 300 AMP	T-VER-8051-300	\$642		S-UCC-M006		CABLE-2.5-STEREO		x	x	x		x	
Kilowatt Hours (kWh) 3 phase, 800 AMP	T-VER-8053-800	\$849		S-UCC-M006		CABLE-2.5-STEREO		x	x	x		x	
Kilowatt Hours (kWh) Delta/Wye 240	T-WNB-3D-240	\$269		S-UCC-M006 & T-MAG-SCT-xxx		CABLE-2.5-STEREO		x	x	x		x	
Kilowatt Hours (kWh) Delta/Wye 480	T-WNB-3D-480	\$269		S-UCC-M006 & T-MAG-SCT-xxx		CABLE-2.5-STEREO		x	x	x		x	
Kilowatt Hours (kWh) Delta/Wye 208/240	T-WNB-3Y-208	\$229		S-UCC-M006 & T-MAG-SCT-xxx		CABLE-2.5-STEREO		x	x	x		x	
Kilowatt Hours (kWh) Delta/Wye 208/240	T-WNB-3Y-208-P	\$249		S-UCC-M006 & T-MAG-SCT-xxx		CABLE-2.5-STEREO		x				x	
Power (kW) 3 phase, 100 AMP	T-VER-8044-100	\$815	Built in VIA	S-FS-CVIA		CABLE-4-20mA & AC-SENS-1		x	x		x	x	
Temperature	S-TMB-MOXX	\$95-\$120						x	x	x			
Air Water Soil Temperature	TMCx-HD	\$32-42									x	x	
Pipe Temperature	TMC6-HE	\$35									x	x	
Stainless Steel Temp Probe	TMC6-HC	\$79									x	x	
Relative Humidity & Temperature	S-THB-M00x	\$189-\$195						x	x	x			
Relative Humidity	T-VAI-HMD-40Y	\$299	Built in VIA	S-FS-CVIA			12 VDC, 20mA	x	x				
Volatile Organic compound (VOC)	T-ION-TVOC	\$2,995	Built in VIA	S-FS-CVIA		CABLE-4-20mA & AC-SENS-1	12 VDC, 300mA	x	x		x	x	
Water Flow Meter	T-MINOL-130	\$105		S-UCC-M006		CABLE-2.5-STEREO		x	x	x		x	
Analog and Digital Adapters for connecting sensors				Notes									
0-5 Volt DC	S-VIA-CM14	\$85						x	x	x			
4-20mA	S-CIA-CM14	\$85						x	x	x			
4-20mA Input cable	CABLE-4-20mA	\$25									x	x	
0-10 Volt DC Input Cable	CABLE-ADAP10	\$12									x	x	
0-5 Volt DC Input cable	CABLE-ADAP5	\$12									x	x	
0-2.5 Volt DC Input cable	CABLE-2.5-STEREO	\$9									x	x	
Pulse input	CABLE-2.5-STEREO	\$9										x	
Pulse input	S-UCC-M00x	\$70-\$75						x	x	x			
Pulse input	S-UCC-M00x	\$70-\$75						x	x	x			
Analog Input Adapter	S-FS-CVIA	\$89							x				
TRMS Input Module	S-FS-TRMSA	\$95							x				
TRMS Smart Input Module	S-FS-TRMSA-D	\$105						x	x				
U30 Built in Analog Input Port (2 inputs)	VIA	\$89						x					

*4-20mA output option requires CABLE-4-20mA

Prices subject to change

Weather/Environmental



Barometric Pressure
\$249 S-BPB-CM50
 50 cm (20 in) Cable

Range: 660 mbar to 1070 mbar (19.47 to 31.55 in. Hg)
 Accuracy: ± 3.0 mbar (0.088 in. Hg) over full pressure range at 25°C (77° F) max error of ± 5.0 mbar (0.148 in. Hg) over -40 to +70C (-40 to +158F)
 Resolution: 0.1 mbar (0.003 in. Hg)
 User connection: 2-wire input (24 AWG wire; 2 wire nuts included)

*Includes cable ties for mast mounting.
 Recommended for use with the HOBO Remote Monitoring System.*

	√	◆	√		
Compatible with:	U30	H22-001	H21-002	U12	ZW



Leaf Wetness
\$110 S-LWA-M003
 Sensor Plate
 4.7 x 5.1 cm
 (1.8 x 2.0 in) Tube
 12.2 cm x 1.8 cm diameter
 (4.8 x 0.7 in) Cable 3 m (9.8 ft)

Range: 0 (dry) to 100% (wet)
 Sensor Type: Capacitive Grid
 Repeatability: ± 5%
 Resolution: 0.59%

Includes mounting bracket. Adjustable angle allows better matching to leaf characteristics.

	√	◆	√		
Compatible with:	U30	H22-001	H21-002	U12	ZW



Photosynthetically Active Radiation (PAR)
\$220 S-LIA-M003
 3 m (9.8 ft) Cable

Range: 0 to 2500 µmol/m²/sec
 Spectral range: 400 to 700 nm
 Accuracy: ± 5 µmol/m²/sec or ± 5%, whichever is greater in sunlight. Cosine corrected 0 to 80 degrees
 Resolution: 2.5 µmol/m²/sec

Light sensor bracket (M-LBB) and light sensor level (M-LLA) recommended.

	√	◆	√		
Compatible with:	U30	H22-001	H21-002	U12	ZW



Solar Radiation (Silicon Pyranometer)
\$210 S-LIB-M003
 3 in 9.8 ft) Cable

Range: 0 to 1280 W/m²
 Spectral range: 300 to 1100 nm
 Accuracy: ±10W/m² or ±5% whichever is greater in sunlight. Cosine corrected 0 to 80 degrees
 Resolution: 1.25 W/m²

Light sensor bracket (M-LBB) and light sensor level (M-LLA) recommended.

	√	◆	√		
Compatible with:	U30	H22-001	H21-002	U12	ZW



◆ These sensors are not generally used with the H22-001, but they are compatible as long as the H22 is in an indoor environment



Mechanism: Tipping bucket, with 154 mm (6.06 in) receiving orifice
 Range: Up to 12.7 cm/hr or 5 in/h, maximum 4000 tips per interval
 Resolution: 0.2 mm (S-RGB) and 0.01 in. (S-RGA)
 Calibration accuracy: $\pm 1.0\%$ at up to 20 mm/hour or 1 in/hour
Comes with side bracket for post or tripod mount and feet for surface mount.

Rain Gauge Smart Sensors

\$420

0.2 mm: S-RGB-M002

0.01in: S-RGA M002

Cable 2 m (6.5 ft)

	√	◆	√		
Compatible with:	U30	H22-001	H21-002	U12	ZW



Soil Moisture-ECHO-20

\$139 S-SMA-M005

254 x 32 x 1.0 mm

(10 x 1.25 x 0.04 in)

Cable 5 m (16 ft)

Range: 0 to 0.40 m³/m³ volumetric water content
 Accuracy: Typical: ± 0.041 m³/m³ ($\pm 4\%$) up to 1ds/m,
 ± 0.020 m³/m³ ($\pm 2\%$) with soil-specific calibration
 Resolution: ± 0.0004 m³/m³ ($\pm 0.04\%$)

	√	◆	√		
Compatible with:	U30	H22-001	H21-002	U12	ZW



Soil Moisture-ECHO-10

\$139 S-SMB-M005

152 x 32 x 1.0 mm

(6 x 1.25 x 0.04 in)

Cable 5 m (16 ft)

Range: 0 to 0.40 m³/m³ volumetric water content
 Accuracy: Typical: ± 0.041 m³/m³ ($\pm 4\%$) up to 1ds/m,
 ± 0.020 m³/m³ ($\pm 2\%$) with soil-specific calibration
 Resolution: ± 0.0006 m³/m³ ($\pm 0.06\%$)

	√	◆	√		
Compatible with:	U30	H22-001	H21-002	U12	ZW



Soil Moisture-ECHO-5

\$139 S-SMC-M005

89 x 15 x 1.5 mm

(3.5 x 0.62 x 0.06 in)

Cable 5 m (16 ft)

Range: 0 to 1.00 m³/m³ volumetric water content (0 to 100%)
 Accuracy: Typical: ± 0.031 m³/m³ ($\pm 3\%$) up to 8 ds/m,
 ± 0.020 m³/m³ ($\pm 2\%$) with soil-specific calibration
 Resolution: ± 0.0007 m³/m³ ($\pm 0.07\%$)

	√	◆	√		
Compatible with:	U30	H22-001	H21-002	U12	ZW

◆ These sensors are not generally used with the H22-001, but they are compatible as long as the H22 is in an indoor environment



12-bit Temperature
\$95-\$120 S-TMB-MOxx
 2 m, 6 m, 17 m
 cable lengths available:
 (6.5 ft, 20 ft, 56 ft)

Range: -40° to 75°C (-40° to 167°F)
 Accuracy: ± 0.2° from 0° to 50°C (±0.36° from 32° to 122°F)
 Resolution: 0.03° from 0° to 50°C (0.054° from 32° to 122°F)
 Environment: Sensor tip and cable rated for 1-year immersion
 in fresh water ≤ 50°C (122°F)
 Response Time: < 3 minutes (to 90% in airflow of 1 m/s)
*Solar radiation shield (RS3) recommended for accurate temperature
 measurements in sunlight.*

	√	√	√		
Compatible with:	U30	H22-001	H21-002	U12	ZW



Temperature/RH
\$189-\$195 S-THB-M00x
 cable lengths available
 2 m, 8 m, (6.5 ft, 26 ft)

Ranges: -40° to 75°C (-40° to 167°F); 0 to 100%
 Accuracy: RH from -40° to 75°C (-40° to 167°F)
 ± 0.2° @ 25°C (±0.36° @ 77°F);
 ± 2.5% typical, 3.5% maximum, from 10 - 90% RH
 Resolution: 0.02° @ 25°C (0.04° @ 77°F); 0.1% RH @ 25°C (77°F)
 Response Time: Temp: 5 minutes, RH: 5 minutes (to 90% in airflow of 1 m/s)
 Data Channels: 2
*Solar radiation shield (RS3) recommended for accurate
 temperature measurements in sunlight.*

	√	√	√		
Compatible with:	U30	H22-001	H21-002	U12	ZW



Wind Speed
\$239 S-WSA-M003
 3 m (9.8 ft) Cable

Range: 0 to 45 m/s (0 to 100 mph)
 Accuracy: ± 1.1 m/s (2.4 mph) or ± 4% of reading, whichever is greater
 Resolution: 0.38 m/s
 Starting threshold: ≤1 m/s (2.2 mph)
 Data channels: 2 (average wind speed and highest 2 sec gust) Survival to 54 m/sec (120 mph)
*Cross arm or pole mount recommended (2x hose clamps required for pole
 mount).*

	√	♦	√		
Compatible with:	U30	H22-001	H21-002	U12	ZW



Wind Speed & Direction
\$540 S-WCA-M003
 3 m (9.8 ft) Cable

<p>Range: 0 to 44 m/s (0 to 99 mph) Greater of ± 0.5 m/s (1.1 mph) Accuracy: or ±4% of reading Resolution: 0.19 m/s Starting threshold: ≤0.5 m/s, (1.1 mph) Data channels: 3 (average wind speed, direction, and highest 3 second gust) <i>Survival to 54 m/sec (120 mph). Cross arm recommended for mounting. Grounding wire required for using this sensor with H21-002 Micro Station. Either the CABLE-HWS-G or CABLE-HWS-F can be used.</i></p>	<p><u>Speed</u></p>	<p><u>Direction</u></p> <p>0-358°, 2° dead band ±5° 1.4 degrees</p>
---	---------------------	---

	√	♦	√		
Compatible with:	U30	H22-001	H21-002	U12	ZW

♦ These sensors are not generally used with the H22-001, but they are compatible as long as the H22 is in an indoor environment



**R.M. Young
Wind Monitor-AQ
(model 05305) Adapter
\$150 S-WCB-M003**

3m (9.8 ft) cable from the adapter housing that plugs into logger. Adapter housing dimensions – 19.6 cm(7.7 in) long, 2.7 cm (1.05 in) diameter

Range:	0 to 50 m/s (0 to 112 mph)	<u>Direction</u>	0 to 355 degrees
Accuracy (adapter only):	0.20 m/s (0.46 mph)		1.4 degrees
Resolution:	0.20 m/s (0.46 mph)		1.4 degrees
Data channels:	3 (average wind speed, direction, and highest 3 second gust)		

NOTE: This adapter is not compatible with models 05305L or 05305V

	√	♦	√		
Compatible with:	U30	H22-001	H21-002	U12	ZW



**R.M. Young
Marine Wind Monitor
(model 05106) Adapter
\$150 S-WCC-M003**

3m (9.8 ft) cable from the adapter housing that plugs into logger
Adapter Housing Dimensions – 19.6 cm(7.7 in) long, 2.7 cm (1.05 in) diameter.

Range:	0 to 50 m/s (0 to 111 mph)	<u>Direction</u>	0 to 355 degrees
Accuracy (adapter only):	0.20 m/s (0.46 mph)		1.4 degrees
Resolution:	0.20 m/s (0.44 mph)		1.4 degrees
Data channels:	3 (average wind speed, direction, and highest 3 second gust)		

NOTE: This adapter is not compatible with models 05603C or 05631C

	√	♦	√		
Compatible with:	U30	H22-001	H21-002	U12	ZW



**R.M. Young
Wind Sentry
(model 03002) Adapter
\$150 S-WCD-M003**

3m (9.8 ft) cable from the adapter housing that plugs into logger
Adapter Housing Dimensions – 19.6 cm(7.7 in) long, 2.7 cm (1.05 in) diameter

Range:	0 to 50 m/s (0 to 112 mph)	<u>Direction</u>	0 to 355 degrees
Accuracy (adapter only):	0.25 m/s (0.55 mph)		1.4 degrees
Resolution:	0.25 m/s (0.55 mph)		1.4 degrees
Data channels:	3 (average wind speed, direction, and highest 3 second gust)		

NOTE: This adapter is not compatible with models 03002L or 03002M

	√	♦	√		
Compatible with:	U30	H22-001	H21-002	U12	ZW



**R.M. Young
Wind Monitor adapter for Wind/Alpine
(models 05103, and 05103-45)
\$150 S-WCE-M003**

3m (9.8 ft) cable from the adapter housing that plugs into logger
Adapter Housing Dimensions – 19.6 cm(7.7 in) long, 2.7 cm (1.05 in) diameter

Range:	0 to 52 m/s (0 to 116 mph)	<u>Direction</u>	0 to 355 degrees
Accuracy (adapter only):	(adapter only): 0.20 m/s (0.46 mph)		1.4 degrees
Resolution:	0.20 m/s (0.46 mph)		1.4 degrees
Data channels:	3 (average wind speed, direction, and highest 3 second gust)		

NOTE: This adapter is not compatible with models 05103L, 05103V, 05103L-45, or 05103V-45

	√	♦	√		
Compatible with:	U30	H22-001	H21-002	U12	ZW

♦ These sensors are not generally used with the H22-001, but they are compatible as long as the H22 is in an indoor environment

Analog and digital Adapters for connecting sensors



0-5V Input Adapter
\$75 S-VIA-CM14

Range: 0-5V DC
Accuracy: ±0.025V
Resolution: 1.221 millivolts
Sensor trigger: Open collector or 2.5V

	√	√	√		
Compatible with:	U30	H22-001	H21-002	U12	ZW



4-20mA Input Adapter
\$85 S-CIA-CM14

Range: 0-20 mA
Accuracy: ±0.1 mA
Resolution: ±4.93 µA
Choice of non-switched or switched input to save external battery power
Sensor trigger: 2.5 V

	√	√	√		
Compatible with:	U30	H22-001	H21-002	U12	ZW



Electronic Pulse Input Adapter
\$70-\$75 S-UCC-M00X
cable lengths available:
1 M, 6 M, (3.3 ft, 21 ft)

Maximum Frequency: 120 Hz (120 pulses per second)
Range: 0-65, 533 counts per logging interval
User Connection: 2-wire input (wire nuts included)

	√	√	√		
Compatible with:	U30	H22-001	H21-002	U12	ZW



Contact Closure Pulse Input Adapter
\$70-\$75 S-UCD-M00X
cable lengths available:
1 M, 6 M, (3.3 ft, 21 ft)

Maximum Frequency: 120 Hz (120 pulses per second)
Range: 0-65, 533 counts per logging interval
User Connection: 2-wire input (wire nuts included)

	√	√	√		
Compatible with:	U30	H22-001	H21-002	U12	ZW



U30 Built in Analog Input Port (2 inputs)
\$89 S-VIA-CM14

Inputs: 2 channels – User configured as 0-20mA or 0-20VDC
Sensor Power: Switched 12 VDC, up to 50 mA: user-selectable warm-up from 5 milliseconds to 2 minutes
Scaling: Linear scaling to user units
Accuracy: +/- 0.25% full scale

	√				
Compatible with:	U30	H22-001	H21-002	U12	ZW

Sensors

Energy Sensors



AC Voltage

\$139 T-CON-ACT-xxx

11.4 x 7.3 x 3.25 cm
(4.49 x 2.87 x 1.28 in)
300 g (10.6 oz)

Ranges: 90 to 150 or 180 to 300 volts RMS

Accuracy: 0.1% of span

Self-powered transmitter for monitoring sine wave, single-phase 60Hz AC voltage. Requires 4-20mA Input Cable (CABLE-4-20mA) for use with HOBO U12 loggers.

				√	√
Compatible with:	U30	H22-001	H21-002	U12	ZW

Split-Core AC
Current Sensors**\$90-\$115 CTV-x**

Cable length: 1.8 m (6 ft)

Ranges: 0-20, 0-50, 0-100, 0-200, 0-600

Accuracy: ± 4.5% of full scale

				√	√
Compatible with:	U30	H22-001	H21-002	U12	ZW



AC Current

\$55-\$65 T-MAG-SCT-XXX

Ranges: 0-5, 0-20, 0-50, 0-100, 0-200, 0-600 Amps

Accuracy: ±1% (from 10% to 130% of rated voltage)

	√	√			
Compatible with:	U30	H22-001	H21-002	U12	ZW



AC Voltage

\$75 T-MAG-SPT-XXX

Ranges: 0-150, 0-300, 0-600 volts

Accuracy: ±1% (from 10% to 130% of rated voltage)

	√	√			
Compatible with:	U30	H22-001	H21-002	U12	ZW



Air Velocity Sensor
 \$235 T-DCI-F900-S-P
 T-DCI-F900-S-O

Ranges: 0.15 to 10 m/s (30 to 1969 fpm)
 Accuracy: Greater of 10% of reading or +/- 0.05 m/s or 1% full-scale
 Ranges: 0.15 to 5 m/s (30 to 985 fpm)

	√	√		√	√
Compatible with:	U30	H22-001	H21-002	U12	ZW

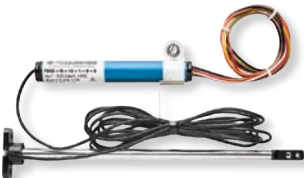

Air Velocity Sensor
 \$319 T-DCI-F900-L-P
 T-DCI-F900-L-O

Ranges: 0.15 to 10 m/s (30 to 1969 fpm)
 Accuracy: Greater of 10% of reading or +/- 0.05 m/s or 1% full-scale
 Ranges: 0.15 to 5 m/s (30 to 985 fpm)

	√	√		√	√
Compatible with:	U30	H22-001	H21-002	U12	ZW



Carbon Dioxide/Temp
 \$465 TEL-7001

Ranges: 0 to 2500 ppm CO₂ , 0° to 40°C (32° to 104°F)
 Accuracy: ±50ppm or ±5% of reading; ±1°C (±2°F)

	√	√		√	√
Compatible with:	U30	H22-001	H21-002	U12	ZW



Compressed Air Flow Meter
 \$495 T-CDI-5200-10S

Ranges: 1 to 80 SCFM
 Accuracy: calibrated range: 5% of reading plus 1% of F.S. between 40° and 120° F
Can be configured for either analog or pulse output.

	√	√	√		√
Compatible with:	U30	H22-001	H21-002	U12	ZW



Compressed Air Flow Meter
 \$629 T-CDI-5400-20S

Ranges: 3 to 350 SCFM (3 to 600 SCFM extended range)
 Accuracy: calibrated range: 5% of reading plus 1% of F.S. between 40° and 120° F
Can be configured for either analog or pulse output.

	√	√	√		√
Compatible with:	U30	H22-001	H21-002	U12	ZW



**Split-Core Bi-Polar
DC Transducer**
\$229 T-VER-971BP-200

Ranges: -200 to 200 Amps DC
Accuracy: +/- 0.5A F.S.

	√	√		√	√
Compatible with:	U30	H22-001	H21-002	U12	ZW



**Split-Core 200A
DC Transducer**
\$205 T-VER-H970-200

Ranges: 0 to 200 Amps DC (selectable 0-50, 0-100, 0-200)
Accuracy: +/- 3% F.S.

	√	√		√	√
Compatible with:	U30	H22-001	H21-002	U12	ZW



**Differential Air Pressure
Transducer with LCD**
\$220 T-VER-PXU-L

Ranges: User selectable: 0.1; 0.25; 0.50; 1.0; 2.5; 5.0; 10.0 "WC
(inches of water column)
Accuracy: +/- 1% F.S. of selected range

	√	√		√	√
Compatible with:	U30	H22-001	H21-002	U12	ZW



**Differential Air
Pressure Transducer**
\$195 T-VER-PXU-X

Ranges: User selectable: 0.1; 0.25; 0.50; 1.0; 2.5; 5.0; 10.0 "WC
(inches of water column)
Accuracy: +/- 1% F.S. of selected range

	√	√		√	√
Compatible with:	U30	H22-001	H21-002	U12	ZW





Gauge Pressure
\$190 T-ASH-G2-XXX

Ranges: 0-100, 0-200, 0-500 psig
Accuracy: ±1% of span from -20° to 85°C (-4° to 185°F)

	√	√		√	√
Compatible with:	U30	H22-001	H21-002	U12	ZW



kWh Transducer
\$642-\$849
T-VER-805X-XXX

Ranges: 208 to 480 VAC, 300 Amps, 1-phase
208 to 480 VAC, 800 Amps, 3-phase

	√	√	√		√
Compatible with:	U30	H22-001	H21-002	U12	ZW

Self-contained unit includes split-core AC current transformers and voltage leads to provide kilowatt hours of energy used.

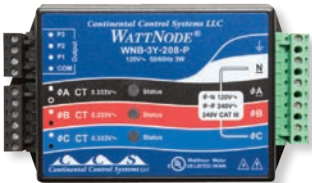

kWh Transducer
\$229-\$269
T-WNB-3X-XXX

Ranges: 208/240 VAC and 480 VAC ±15% Delta and Wye systems
Accuracy: ±0.45% of reading ±0.05% FS through 25th harmonic

	√	√	√		√
Compatible with:	U30	H22-001	H21-002	U12	ZW

Works with CTs (T-MAG-SCT-XXX) to provide True RMS kilowatt hours of energy used, even for loads with non-sinusoidal waveforms.



kW Transducer
\$815 T-VER-8044-100

Ranges: 3 phase, 50/60 Hz, 480 VAC, 0 to 100 Amps
Accuracy: ±3% per ANSI C12.1 (from 10% to 100% of CT rating)

	√	√		√	√
Compatible with:	U30	H22-001	H21-002	U12	ZW

Sensors



12-bit Temperature
\$95-\$120 S-TMB-MOxx
 2 m, 6 m, 17 m
 cable lengths available:
 (6.5 ft, 20 ft, 56 ft)

Range: -40° to 75°C (-40° to 167°F)
 Accuracy: ± 0.2° from 0° to 50°C (±0.36° from 32° to 122°F)
 Resolution: 0.03° from 0° to 50°C (0.054° from 32° to 122°F)
 Environment: Sensor tip and cable rated for 1-year immersion
 in fresh water ≤ 50°C (122°F)
 Response Time: < 3 minutes (to 90% in airflow of 1 m/s)
*Solar radiation shield (RS3) recommended for accurate temperature
 measurements in sunlight.*

	√	√	√		
Compatible with:	U30	H22-001	H21-002	U12	ZW



Air/Water/Soil/Temperature
\$32-\$42 TMCx-HD
 Sensor diameter:0.5 cm
 (0.2 in) diameter
 Cable lengths: 0.3, 1.8, 6.1, 15.2 m
 (1, 6, 20, 50 ft) available

Range: -40° to 100°C (-40° to 212°F) in air;
 -40° to 50°C (-40° to 122°F) in water or soil
 Accuracy: ± 0.21°C from 0° to 50°C (0.38°F from 32° to 122°F)
 Resolution: 0.03° @ 25°C (0.05° @ 77°F)
 Response time: 3 minutes (to 90% in airflow 1 m/s); 1 minute in water

				√	√
Compatible with:	U30	H22-001	H21-002	U12	ZW

*Note: Sensor tip and cable immersion in fresh water up to 50°C (122°F) for
 one year; radiation shield (RS3) recommended for use in sunlight*



Stainless Steel
Temperature Probe
\$79 TMC6-HC
 0.3 cm diameter x 10.2 cm
 (0.12 in x 4 in)
 cable length: 1.8 m (6 ft)

10.2 cm (4 in) food-grade stainless-steel probe with pointed tip; 0.3 cm
 (0.12 in) diameter, 1.8 m (6 ft) cable
 Range: -40° to 100°C (-40° to 212°F) in air;
 -40° to 50°C (-40° to 122°F) in water or soil
 Accuracy: ± 0.21°C from 0° to 50°C (0.38°F from 32° to 122°F)
 Resolution: 0.03° @ 25°C (0.05° @ 77°F)
 Response time: 3 minutes (to 90% in air moving 1 m/s); 15 seconds in stirred water

				√	√
Compatible with:	U30	H22-001	H21-002	U12	ZW



Temperature Sensor
\$35 TMC6-HE
 0.3 cm diameter x 10.2 cm
 (0.12 in x 4 in)
 cable length: 1.8 m (6 ft)

Range: -40° to 100°C (-40° to 212°F) in air
 Accuracy: ± 0.21°C from 0° to 50°C (0.38°F from 32° to 122°F)
 Resolution: 0.03 @ 20°C (0.05° @ 68°F)
 Response time: In air: 2 minutes typical to 90% in air moving 1 m/s
On a pipe: Typically 2 times faster than the TMCX-HD. Typically less than 1
 minute to 90%.

				√	√
Compatible with:	U30	H22-001	H21-002	U12	ZW



Temperature/RH
\$189-\$195 S-THB-M00x
 cable lengths available
 2 m, 8 m, (6.5 ft, 26 ft)

Ranges: -40° to 75°C (-40° to 167°F); 0 to 100%
 RH from -40° to 75°C (-40° to 167°F)
 Accuracy: ± 0.2° @ 25°C (±0.36° @ 77°F);
 ± 2.5% typical, 3.5% maximum, from 10 - 90% RH
 Resolution: 0.02° @ 25°C (0.04° @ 77°F); 0.1% RH @ 25°C (77°F)
 Response Time: Temp: 5 minutes, RH: 5 minutes (to 90% in airflow of 1 m/s)
 Data Channels: 2
Solar radiation shield (RS3) recommended for accurate temperature measurements in sunlight.

	√	√	√		
Compatible with:	U30	H22-001	H21-002	U12	ZW

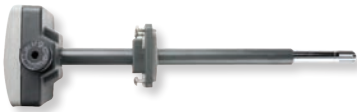

Duct-Mount Humidity/Temp
\$299 T-VAI-HMD-40Y

Ranges: 10 to 90% RH
 Temp: -10° to 60°C (14° to 140°F)
 Accuracy: better than ±3% RH @ 25°C (77°F); ±0.3° temp @ 25°C (±0.54° @ 77°F)

	√	√			
Compatible with:	U30	H22-001	H21-002	U12	ZW



Volatile Organic Compound (VOC) Sensor
\$2,995 T-ION-TVOC

Range: selectable 0 - 10, 0 - 100, 0 - 1000 ppm (parts per million)
 Accuracy: (0-10 and 0-100 ppm) +/- 2%; (100-1000 ppm) +/- 5%
 Linearity: (0 - 100 ppm) > 98%
 Response time: sensor T90 < 5 sec.

	√	√		√	√
Compatible with:	U30	H22-001	H21-002	U12	ZW



Water Flow Meter Sensor
\$105 T-MI NOL-130

Ranges: 0 to 22 gpm (gallon per minute)
 Accuracy: 0.25-1 gpm

	√	√	√		√
Compatible with:	U30	H22-001	H21-002	U12	ZW

Sensors

Analog and Digital Adapters for Connecting Sensors



4-20mA Cable
\$25 CABLE-4-20mA
 45.7 cm (18 in) cable
 with 8.9 cm (3.5 in)
 tinned braided wire leads

Range: 0 to 20.1 mA
 Accuracy: ± 0.02 mA, $\pm 2.5\%$ of reading
 Resolution: 0.03% of full scale

	√	√	√		
Compatible with:	U30	H22-001	H21-002	U12	ZW

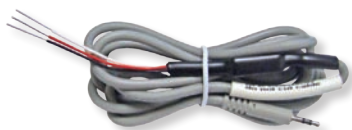

Voltage Input Adapter Cable
\$12 CABLE-ADAPX
 Length 1.9m (6.3 ft.)
 Weight 38.6g (1.4 oz.)

Accuracy: CABLE-ADAP5 provides user analog sensor input of 0-5 Vdc max.
 CABLE-ADAP10 provides user analog sensor input of 0-10 Vdc max.
 Max. error of .2%

				√	√
Compatible with:	U30	H22-001	H21-002	U12	ZW



Voltage Input Cable
\$9 CABLE-2.5-STEREO
 1.8 m (6 ft) cable with 1.27 cm
 (0.5 in) tinned braided wire leads

For voltage input specifications, refer to the external input specifications of the model you will be using.

				√	√
Compatible with:	U30	H22-001	H21-002	U12	ZW



FlexSmart Analog Module (2 channels)
\$89 S-FS-CVIA

User-configurable
 Ranges: 0-20mA, 0-20VDC (suitable for 2.5, 5, and 10V sensors)
 Accuracy: $\pm 0.25\%$ FS over range selected from 50mV to FS
 Provides 12V sensor excitation

		√			
Compatible with:	U30	H22-001	H21-002	U12	ZW



FlexSmart Analog Module (2 channels) w/modular plug
\$105 S-FS-TRMSA-D
 3.5cm x 5.7cm x 1.9cm (1.38 in.
 x 2.25 in. x 0.75 in.)

Range: 5mV to 512mV input; compatible with 333mV FS output sensors
 Accuracy: $\pm 0.3\%$ of reading $\pm 0.5\%$ FSR*
 *Crest factor may cause additional error

	√	√			
Compatible with:	U30	H22-001	H21-002	U12	ZW

Onset offers a range of data retrieval and communication options to make data offload from HOBO loggers fast and easy.



HOBO U-Shuttle

\$260 U-DT-1

11.0 x 6.9 x 2.7 cm
(4.35 x 2.7 x 1.05 in)
153 g (5.4 oz)

- Enables convenient, easy data offload from HOBO U-Series, H21 and H22 data loggers (Base Station required for Optic USB loggers)
- Provides safe transport of data back to a PC or Mac
- Stores data from multiple data loggers
- Displays logger status, including memory, battery level, and sensor readings for some sensors (on some models)
- CABLE-HOBO-SHTL and CABLE-USBMB included

Specifications:

4 MB non-volatile memory: 504 8K loggers, 63 64K loggers, 7 readouts of 512k loggers
Operating temperature range 0° to 50°C (32° to 122°F)
Battery life: 1-year (typical) — user-replaceable
Requires HOBOWare Pro Software 2.2 or greater



HOBO U30 Shuttle

\$260 U-DT-2

11.0 x 6.9 x 2.7 cm
(4.35 x 2.7 x 1.05 in)
153 g (5.4 oz)

- Enables convenient, easy data offload from HOBO U30 Series, H21 and H22 data loggers
- Provides safe transport of data back to a PC or Mac
- Stores data from multiple data loggers
- Displays logger status, including memory, battery level, and sensor readings for some sensors
- CABLE-HOBO-SHTL and CABLE-USBMB included

Specifications:

4 MB non-volatile memory: 7 readouts of 512K loggers
Operating temperature range 0° to 50°C (32° to 122°F)
Battery life: 1-year (typical) 50 complete memory fills - user replaceable
Requires HOBOWare Pro Software 2.6 or greater



HOBO Waterproof Shuttle

\$230 U-DTW-1

15.2 x 4.8 cm
(6.0 x 1.9 in)
150 g (5.3 oz)

- Can be used either as a data shuttle or an Optic USB Base Station
- Supports all HOBO Optic USB loggers
- Outdoor or underwater data readout
- Convenient direct USB connection to host computer
- Waterproof to 20 m
- Checks and indicates its own battery status

Specifications:

4 MB non-volatile memory: up to 63 loggers
Operating temperature range 0° to 50°C (32° to 122°F)
Battery life: 1-year (typical) — user-replaceable
Requires HOBOWare Pro Software



Optic USB Base Station

\$115 BASE-U-4

15.2 x 4.8 cm
(6.0 x 1.9 in)
150 g (5.3 oz)

- Provides fast optical infrared (IR) communications for easy launch and readout of all HOBO Optic USB loggers
- Splash-resistant

Specifications:

Operating temperature range 0° to 50° C (32° to 122° F)
Cable length 183 cm (6 ft)
Offloads full 64K logger in 30 seconds



Pendant Base Station

\$65 BASE-U-1

9.5 x 4 x 2.8 cm
(3.75 x 1.6 x 1.1 in)
45 g (1.6 oz)

- Provides fast optical infrared (IR) communications for easy launch and readout of all HOBO Pendant loggers
- Connects via USB cable to host computer while Coupler attaches the logger to Base Station
- Splash-resistant

Specifications:

Operating temperature range 0° to 50° C (32° to 122° F)
Cable length 183 cm (6 ft)
Offloads full 64K logger in 30 seconds



HOBO Shuttle and Base Station Compatibility						
		U-Shuttle Data Transporter U-DT-1	U30 Shuttle Data Transporter U-DT-2	Waterproof Shuttle U-DTW-1*	Pendant Base Station BASE-U-1	Optic USB Base Station BASE-U-4*
		\$260	\$260	\$230	\$65	\$115
Storage Capacity	504 loggers/8k memory	√				
	63 loggers/64k memory	√		√		
	7 loggers/512k memory	√	√			
HOBO U9		√				
HOBO U10		√				
HOBO U11		√				
HOBO U12 (12-bit Family)		√				
HOBO U12 Outdoor		√				
HOBO U12 Stainless		√				
HOBO Pendant loggers		√B		√	√	√
Pendant Event		√B		√	√	√
HOBO Water Level Loggers		√B		√		√
HOBO Water Temp Pro V2		√B		√		√
HOBO Pro V2		√B		√		√
TidbiT Temp V2		√B		√		√
Rain Gauge		√B		√	√	√
HOBO Micro Station		√	√			
HOBO Energy Logger		√	√			
HOBO U30 Remote Monitoring Systems			√			

Products with a "√B" require a base station for use with the U-Shuttle. * Couplers are included

Ordering Information

Data Shuttle and Base Stations

HOBO Waterproof Shuttle with Couplers*	U-DTW-1	\$230
HOBO U-Shuttle*	U-DT-1	\$260
HOBO U30 Shuttle*	U-DT-2	\$260
Pendant Base Station	BASE-U-1	\$65
Optic USB Base Station with Couplers	BASE-U-4	\$115

*Data Shuttles require HOBOware Pro for offload. See page 52 for details. **Prices subject to change**

Services/Parts/Accessories

Description		Part Number	Price
	NIST Traceable Setup/logger*	NIST-SETUP	\$35
	NIST per-point/channel	NIST-TEMP-POINT	\$35
Computer Interface Cables	Interface cable for most PCs	CABLE-PC-3.5	\$10
	USB Cable for HOBO U-series	CABLE-USBMB	\$10
	USB Interface Cable	ADAPT-SER-USB	\$49
Replacement Batteries	Batteries for HOBO U9, U10, U11, U12, (box of 6) Pendant	HRB-TEMP	\$15
	Replacement 4.5 Ahr battery for U30, w/ cable	HRB-U30-S045	\$25
	Replacement 10 Ahr battery for U30, w/ cable	HRB-U30-S100	\$39
	Battery for HOBO Pro v2 (U23) (single)	HP-B	\$13

*NIST Certification: Test and certify the accuracy of new and previously purchased Onset temperature loggers using standards traceable to the U.S. National Institute of Standards & Technology (NIST). Each logger certified receives a certificate showing the logger's temperature accuracy versus a NIST-traceable standard. Depending on the product, available from -30 to 120°C. Onset's NIST traceable certification complies with ISO 10012-1:1992 (E) requirements (excluding pressure calibration certificates). Onset also offers a Certificate of Compliance which certifies logger compliance with the specifications described in its product manual.

Subminiature Connectors for HOBO Thermocouple Logger	for Type J wire	SMC-J	\$9
	for Type K wire	SMC-K	\$9
	for Type T wire	SMC-T	\$9
Additional Replacement Parts	Replacement O-Ring Kit for U12-015 Stainless Temp EPDM	U12-015-ORING-E	\$13
	Viton	U12-015 ORING-V	\$16
	Replacement Parts Kit (U12/H8)	H8x4-BK	\$29
	Set of two U-bolts (U12-008)	U-Bolt-Kit	\$6
	Replacement RH Sensor for HOBO U23-001	HUM-RHPCB-1	\$65
	Replacement RH Sensor for HOBO U23-002/S-THB/ZW-005 & ZW-007	HUM-RHPCB-2	\$65
	Replacement Sensor for HOBO U14-001	HUM-RHPCB-3	\$55
	Desiccant 25 pack for U23, UA-001	DESICCANT1	\$13
	Desiccant Pack for U12-08	DESIC-PACK	\$8

Prices subject to change

Services/Parts/Accessories

Additional Replacement Parts (continued)

Desiccant pack for HOBO Micro Station, LCD CASE	85-DESICCANT6	\$7
Desiccant pack for U12-008	DESIC-PACK	\$8
Replacement O-Ring Kit (U12-015 Stainless Temp) EPDM	U12-015-ORING-E	\$13
Replacement O-Ring Kit (U12-015 Stainless Temp) Viton	U12-015-ORING-V	\$16
25 small Desiccant Packs for UA and U23 Loggers	DESICCANT1	\$13
Replacement Parts Kit (UA-001/2/4)	UA-PARTSKIT	\$16
Replacement RH Sensor for U23-001	HUM-RHPCB-1	\$65
Replacement RH Sensor for U23-002, S-THB, ZW-005 & ZW-007	HUM-RHPCB-2	\$65
Replacement RH Cap Kit 5-pack (S-THB and U23-002 Cables)	HUM-RHCAP2	\$48
Replacement Sensor Cable for ZW-005 and ZW-007	CABLE-TEMP/RH	\$80

Optic USB Base Station and HOBO Waterproof Shuttle Replacement Couplers

Coupler for HOBO Pendant (with BASE-U-1)	COUPLER-UA	\$16
Coupler for HOBO Pendant (with BASE-U-4 or U-DTW-1)	COUPLER2-A	\$11
Coupler for HOBO Water Level Logger (U20)	COUPLER2-B	\$11
Coupler for HOBO Water Temp Pro v2 (U22) & Conductivity U24	COUPLER2-C	\$11
Coupler for TidbiT v2 (UTBI)	COUPLER2-D	\$11
Coupler for HOBO Pro v2 (U23)	COUPLER2-E	\$11

Additional Accessories

For HOBO Water Temp Pro v2		
Protective Boot, black (Cap included)	BOOT-BLK	\$19
Protective Boot, white (Cap included)	BOOT-WHT	\$19
Replacement Cap for Protective Boot, black	85-CAPLUG-H20-B	\$2
Replacement Cap for Protective Boot, white	85-CAPLUG-H20-W	\$2
For TidbiT v2 Temp Logger		
Protective Boot 5-pack, black	BOOT-TIDBIT-BK	\$25
Protective Boot 5-pack, white	BOOT-TIDBIT-WH	\$25
For HOBO Water Level Logger		
Water Level Logger carrying case	U20-CASE-1	\$30
1/16 in. diameter Teflon-coated stainless steel cable		
50 ft	CABLE-1-50	\$59
300 ft	CABLE-1-300	\$260
Crimp Sleeve (12-pack) for above cables	CABLE-1-CRIMP	\$29
For Temperature Loggers		
Radiation Shield (U23)	RS3	\$59
Voltage Input Cable for		
Mounting Clamp	U23-RS-CLAMPKIT	\$6
(for mounting HOBO U23-001 in the RS1 & M-RSA ,U23-004)		

Submersible Cases and Accessories

To use HOBO U10 and U12 loggers underwater		
Submersible case, dome-top, white or grey	SUBC2-xx	\$39
Dome-top subcase service kit includes:		
1 O-ring, 1 sealant, 1 foam disc, 2 desiccant packs	SUBC2-KIT	\$9
25 Desiccant packs for submersible cases	DESICCANT2	\$18
Sealant for submersible cases	85-ORING	\$2

Factory Battery Replacement and Calibration Services

Contact Onset for RMA# for factory battery replacements		
Email: loggerhelp@onsetcomp.com		
Phone: 508-759-9500/1-800-LOGGERS		
Factory Battery Replacement for HOBO U12 Stainless Temp Logger (U12-005)	contact Onset	\$105
Factory Battery Replacement for HOBO U12 Stainless 5 in		
Probe Temp Logger (U12-015-02)	contact Onset	\$142
Factory Battery Replacement for HOBO Water Temp Pro v2 (U22-001)		\$48
Factory Battery Replacement for HOBO Water Level Logger & Calibration (U20)		\$198
Recalibration service w/3-point certificate of pressure accuracy for HOBO Water Level Logger (U20)		\$95

Prices subject to change

Sales & Support:
Intermountain Environmental, Inc.
(800)948-6236 or (435)755-0774
<http://www.inmtn.com>